









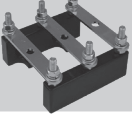

# TERMINAL BLOCK TYPES

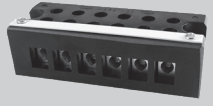
TERMINAL BLOCK TYPE	PAGE #	DESCRIPTION	IMAGE
Studded Feed-Thru	23	Feed-thru terminal blocks are commonly used in telecom panel power distribution units (PDU's) and other applications where external power needs to be transferred to feed a circuit.	
Single Stud Connection	25	Single stud terminals simply provide a single junction point to connect two or more ring type terminals.	
Motor Blocks	26	Motor terminal blocks are specifically intended to be used with electric motor junction boxes to provide delta or wye wiring configurations.	
Grounding Lugs & Connectors	27	These wiring components are intended to be used for grounding in electrical systems.	
Deadfront	28	These rugged terminal blocks provide protection from direct contact with live terminals.	
Barrier	30	These robust style of terminal strips are commonly used in utility panels to aide in the control of power generation and transmission equipment.	
Double Row	31	Barrier terminal strips are the most cost effective means of junctioning wires in lower power applications. Various hardware accessories are available to meet circuit requirements.	
Single Row	33	These terminals are intended for junctioning wires at a single point by means of a bare wire, prepared wire or hardware (quick-connects).	
Military / Navy	35	These terminal blocks are constructed to meet the requirements of Military Specifications A-A-59125 & MIL-T-55164-C, and are only to be used in applications requiring compliance with these specifications.	
DIN Sectionals	37	DIN sectionals provide a compact semi-touch proof construction for a range of wire sizes. These provide end-users the ability to construct terminals to various line lengths per application.	
NEMA® Sectionals	39	NEMA sectionals have an open barrier appearance and style in a sectional construction to provide end-users the ability to construct terminals to various line lengths per application.	

TERMINAL BLOCKS

**Website Resources:**

- Dimensional drawings & 3D CAD files
- Termination and mounting specifications
- Detailed product/series datasheets
- Check distributor stock
- Request samples

NEMA is a trademark of National Electrical Manufacturers Association. All Rights Reserved.

# STUDED FEED-THRU

## ELECTRICAL:

115 to 175 amps  
 300 volts AC/DC (UL)  
 Wire range is determined by the compression lugs used  
 Short circuit current rating (SCCR) of 10K  
 Factory and field wiring

## STANDARDS:

UL 1059 recognized file no. XCFR2.E62806  
 CSA certified file no. LR19766 (CSA C22-2 No. 158)  
 CE (Component IEC 60947-7-1)  
 RoHS compliant (All)

## WEBSITE RESOURCES:

Detailed product data sheets

- Material information
- Termination & mounting specifications
- Multiple wire rating specifications
- Detailed SCCR information

Dimensional drawings & 3D CAD files  
 Accessories available

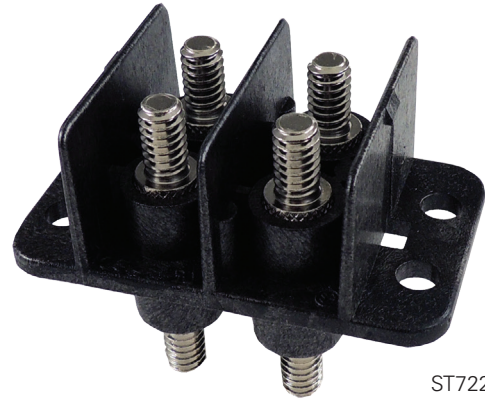

ST722E2502

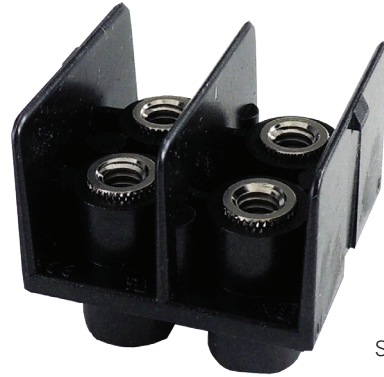

ST722B2502T2

## ORDERING CODE:

SERIES	MOUNTING STYLE (x)	THREAD SIZE (xx)	POLES (xx)	TERMINAL OPTIONS	HARDWARE OPTIONS
ST722	B = Back Mount E = End Mount	25 = 1/4-20 19 = #10-32 M6 = M6 M5 = M5	01 / 02 / 03 / 04 / 05 / 06	Blank = Studs Top & Bot. T1 = Tap Top, Stud Bot. T1S = Stud Top, Tap Bot. T2 = Tap Top & Bot.	Blank – No hardware UH – All nuts shipped bulk AH – All nuts assembled DL – Assembled barrier side, remainder shipped bulk

## COVERS AVAILABLE:

Covers fit all styles available

CATALOG NUMBER	POLES (x)	BASE	FLAMMABILITY
C72201	1	Thermoplastic	UL 94 V-0
C72202	2	Thermoplastic	UL 94 V-0
C72203	3	Thermoplastic	UL 94 V-0
C72204	4	Thermoplastic	UL 94 V-0
C72205	5	Thermoplastic	UL 94 V-0
C72206	6	Thermoplastic	UL 94 V-0

# STUDED FEED-THRU

## ELECTRICAL:

Volts / amps - see table  
 Wire range is determined by the compression lugs used  
 Short circuit current rating (SCCR) of 10K  
 Factory and field wiring

## STANDARDS:

UL 1059 recognized file no. XCFR2.E62806  
 CSA certified file no. LR19766 (CSA C22-2 No. 158)  
 CE (Component IEC 60947-7-1)  
 RoHS compliant (All)

## WEBSITE RESOURCES:

Detailed product data sheets

- Material information
- Termination & mounting specifications
- Multiple wire rating specifications
- Detailed SCCR information

Dimensional drawings & 3D CAD files  
 Accessories available

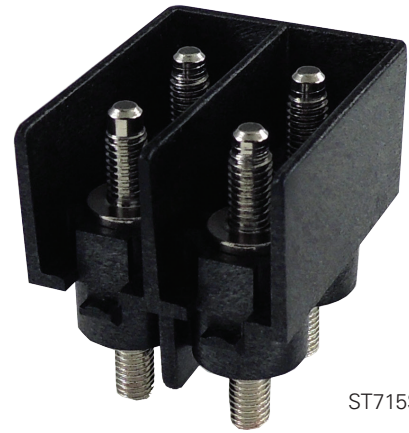

ST715S1902

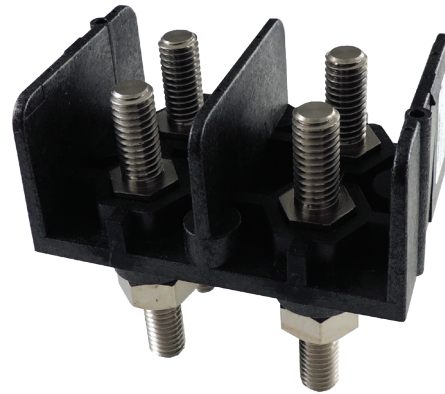

ST723B3802

## ORDERING CODE:

VOLTS	AMPS	SERIES	POLES (xx)	HARDWARE OPTIONS
300	80	ST715S19xx	02	Blank – No hardware UH – All nuts shipped bulk AH – All nuts assembled DL – Assembled barrier side, remainder shipped bulk
600	380	ST723B38xx	01/02	Blank – No hardware UH – All nuts shipped bulk AH – All nuts assembled DL – Assembled barrier side, remainder shipped bulk

# SINGLE STUD CONNECTION

## ELECTRICAL:

300 volts AC/DC (UL)

Designed for two or more wire terminals

## STANDARDS:

RoHS compliant (All)

## WEBSITE RESOURCES:

Detailed product data sheets

- Material information
- Termination & mounting specifications

Dimensional drawings & 3D CAD files

Accessories available

## ORDERING CODE:

CATALOG #	INSULATOR COLOR	STUD SIZE
ST 710 31	Black	5/16"
ST 710 31 RED	Red	5/16"
ST 710 38	Black	3/8"
ST 710 38 RED	Red	3/8"



ST 710 38



ST 710 31 RED

# MOTOR (IEC STYLE)

## ELECTRICAL:

Amps - see table  
 250 - 1100 volts  
 Designed for delta and WYE wiring configurations  
 For use with listed crimp lugs

## STANDARDS:

UL 1059 recognized file no. XCFR2.E62806  
 CSA certified file no. LR19766 (CSA C22-2 No. 158)  
 CE compliant - UL investigated to IEC 60947-7-1, file no. XCHG2.E243117, IEC 60947-7-1  
 UL investigated to SANS 1804-2  
 RoHS compliant (All)

## WEBSITE RESOURCES:

Detailed product data sheets

- Material information
- Termination & mounting specifications
- Multiple wire rating specifications
- Detailed SCCR information

Dimensional drawings & 3D CAD files  
 Accessories available

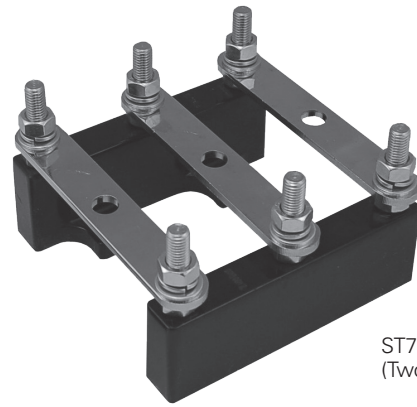

ST750M12  
(Two Piece Style)

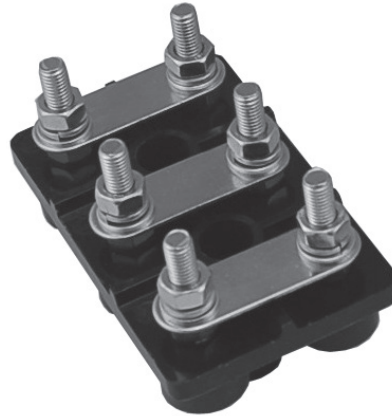

ST750M8  
(One Piece Style)

TERMINAL BLOCKS

CATALOG #	STUD SIZE	STYLE	AMPS		VOLTAGE			WIRE RANGE	OVERALL DIMENSIONS (L x W x H) MM
			cURus	IEC	cURus	IEC	Sans 1804		
ST755M4	M4	One Piece	38	50	300	630	250	#8 - #18 AWG	55 x 33 x 43
ST750M4	M4	One Piece	35	50	1000	1000	1100	#8 - #18 AWG	63 x 37 x 42
ST755M5	M5	One Piece	50	50	600	800	660	#8 - #16 AWG	68 x 40 x 45
ST750M6	M6	One Piece	101	121	1000	1000	1100	#2 - #14 AWG	85 x 50 x 62
ST750M8	M8	One Piece	160	185	1000	1000	1100	2/0 - #12 AWG	112 x 69 x 76
ST755M10	M10	One Piece	185	217	1000	1000	1100	3/0 - #8 AWG	140 x 86 x 91
ST755M12	M12	One Piece	242	271	1000	1000	1100	250 kcmil - #8 AWG	170 x 110 x 97
ST750M12	M12	Two Piece	315	374	1000	1000	1100	400 kcmil - #8 AWG	179 x 167 x 107
ST750M16	M16	Two Piece	560	520	1000	1000	1100	(2) 300 kcmil - (2) #2 AWG	201 x 191 x 133

All blocks include links and hardware assembled

# GROUNDING LUGS & CONNECTORS

## ELECTRICAL:

See table

## STANDARDS:

UL recognized file no. ZMVF2.E43665 (excludes KT375)  
 Supplemental UL Certification: Grounding and bonding equipment (KDER)  
 CSA certified file no. 63510-25  
 Green screwhead for ID (GLxx's only)  
 RoHS compliant (all)

## WEBSITE RESOURCES:

Detailed product data sheets

- Material information
- Termination & mounting specifications

Dimensional drawings & 3D CAD files  
 Accessories available

CATALOG #	WIRE RANGE AWG/kcmil	MOUNTING HOLE DIAMETER
GL02* (9807052)	#2 - #3	.27
	#4 - #6	.27
	#8	.27
	#10 - #14	.27

\*For hex drive screw, catalog number is GL02IH

CATALOG #	WIRE RANGE AWG/kcmil	MOUNTING HOLE DIAMETER
GL20 (9818102)	2/0 - #6	.41
	#8	.41
	#10 - #14	.41

CATALOG #	WIRE RANGE AWG/kcmil	MOUNTING HOLE DIAMETER
GL35 (9819830)	350 kcmil - #6	.53

CATALOG #	WIRE RANGE AWG/kcmil	MOUNTING HOLE DIAMETER
WC12044 (9740701)	(1) 2/0 - #14	.21
	(4) #4 - #14	

CATALOG #	WIRE RANGE AWG/kcmil	MOUNTING HOLE DIAMETER
WC12064 (9797110)	(1) 2/0 - #14	.21
	(6) #4 - #14	

CATALOG #	WIRE RANGE AWG/kcmil	MOUNTING HOLE DIAMETER
KT375	1/4" Quick-connect	.13

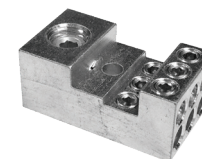
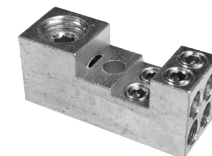
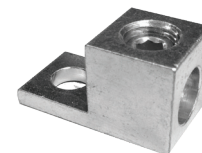
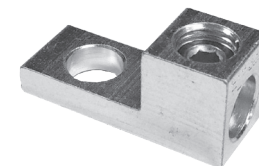

# 1100 & 1200 SERIES

## ELECTRICAL:

Amps - see table  
 600 volts AC/DC  
 Short circuit current rating (SCCR) of 10K

## STANDARDS:

UL 1059 recognized file no. XCFR2.E62806  
 CSA certified file no. LR19766 (CSA C22-2 No. 158)  
 CE (Component IEC 60947-7-1)  
 RoHS compliant (All)

## WEBSITE RESOURCES:

Detailed product data sheets

- Material information
- Termination & mounting specifications
- Multiple wire rating specifications

Dimensional drawings & 3D CAD files  
 Accessories available



1104



1206

AMPS	SERIES	CATALOG #	POLES (x)	WIRE RANGE	POLE TO POLE	SCREWS
65	1100	1102	2	#6 - 18 AWG CU #6 - 12 AWG AL	.44	Brass, Tin Plated
		1104	4			
		1106	6			
		1107	7			
		1108	8			
		1112	12			
70	1200	1202	2	#4 - 18 AWG CU	.50	Steel, Nickel Plated
		1204	4			
		1206	6			

TERMINAL BLOCKS

# 0987 RZ, 985 GP & 885 RZ SERIES

## ELECTRICAL:

Amps - see table  
 600 volts AC/DC  
 Short circuit current rating (SCCR) of 10K

## STANDARDS:

UL 1059 recognized file no. XCFR2.E62806  
 CSA certified file no. LR19766 (CSA C22-2 No. 158)  
 CE (Component IEC 60947-7-1)  
 IP20 touch proof (0987 only)  
 RoHS compliant (All)

## WEBSITE RESOURCES:

Detailed product data sheets

- Material information
- Termination & mounting specifications
- Multiple wire rating specifications

Dimensional drawings & 3D CAD files  
 Accessories available

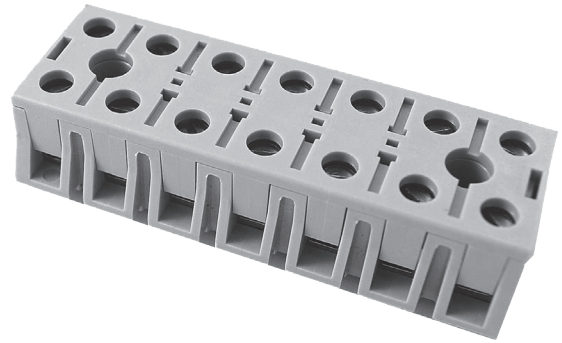

0987 RZ TC 07

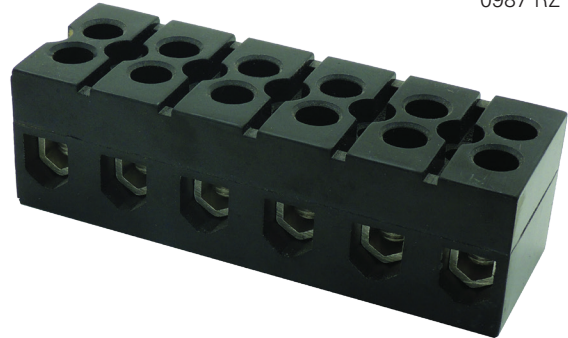

985 GP 06



885 RZ 12

AMPS	CATALOG #	POLES (xx)	WIRE RANGE	INSULATOR BASE	CENTERLINE SPACING
50	0987 RZ TC xx	02, 03, 04, 05, 06, 07, 08, 09, 10, 11, 12	#8 - 24	Thermoplastic, 125°C (UL RTI)	.475"
85	985 GP xx	02, 03, 04, 05, 06, 07, 08, 09, 10, 11, 12	#4 - 18	Phenolic, 150°C (UL RTI)	.625"
85	885 RZ xx	01, 02, 03, 04, 05, 06, 07, 08, 09, 10, 11, 12	#4 - 18	Thermoplastic, 130°C (UL RTI)	.432"



# 1500, 1600 & 1700 SERIES

## ELECTRICAL:

Amps

- 75 w/ prepared wire
- 30 w/ bare wire

600 volts AC/DC

Bare wire range #10 - 22 AWG CU

Accepts lugs with max width of .50 inches

Short circuit current rating (SCCR) of 10K

## STANDARDS:

UL 1059 recognized file no. XCFR2.E62806

CSA certified file no. LR19766 (CSA C22-2 No. 158)

CE (Component IEC 60947-7-1)

RoHS compliant (All)

## WEBSITE RESOURCES:

Detailed product data sheets

- Material information
- Termination & mounting specifications
- Multiple wire rating specifications

Dimensional drawings & 3D CAD files

Accessories available

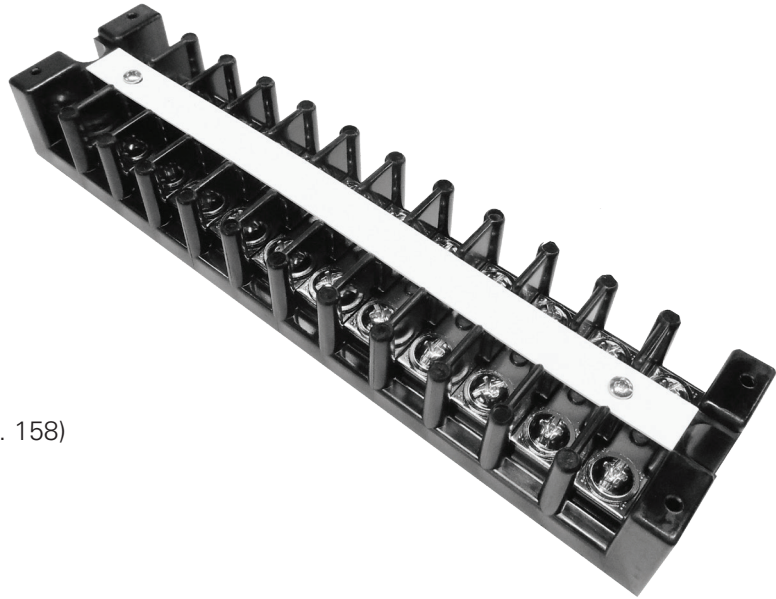

1512 STD

SERIES	BASE CATALOG #	POLES (xx)	INSULATOR BASE	PITCH (POLE TO POLE SPACING)	CLEAR COVER	WHITE COVER
1500	15xx	02, 04, 06, 08, 12	Phenolic (150°C UL RTI)	0.625	CC 15xx	CW 15xx
1600	16xx	02, 04, 06, 08, 12	Phenolic (150°C UL RTI)	0.656	CC 16xx	CW 16xx
1700	17xx	02, 03, 04, 05, 06, 07, 08, 09, 10, 11, 12	Thermoplastic (125°C UL RTI)	0.625	CC 17xx	--

## SERIES CONFIGURATION OPTIONS

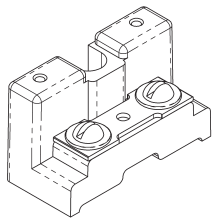
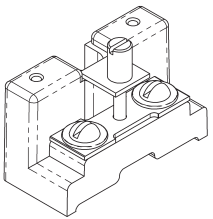
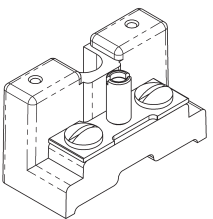
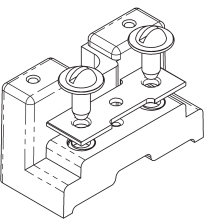
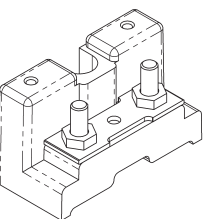
STD	SC	TP	DJ	STRC <sup>1</sup>
1500 1600 1700	1500 1600 1700	1500 1600	1500 1600	1500 1600
				
Standard Connector	Short Circuiting Bar with Brass Insert, 4 Shorting Pins per Block	Test Point, Integrated Female Banana Plug	Removable Connector with Brass Insert	10-32 Stud, Terminals

<sup>1</sup>Stud construction with a removable connector is available as option "ST".

# DOUBLE ROW TERMINAL BLOCKS

**DOUBLE ROW TERMINAL BLOCKS** come in three basic options dependent on base material and style:

- **CLOSED BACK, THERMOPLASTIC** - the ideal option for standard configurations. Generally, these are the most cost effective and are more robust than any other style.
- **CLOSED BACK, PHENOLIC** - this is the second best option for standard configurations where temperature ratings are between 125° C and 150° C.
- **OPEN BACK, PHENOLIC** - should be used only for feed-thru hardware options, and requires an additional insulator strip in order to attain the noted voltage rating.

## ELECTRICAL:

Amps & volts - see table

## STANDARDS:

UL recognized file no. XCFR2.E62806 or E47811  
 CSA certified file no. LR19766 (CSA C22-2 No. 158)  
 CE (Component IEC 60947-7-1)  
 RoHS compliant (All)

## WEBSITE RESOURCES:

Dimensional drawings & 3D CAD files  
 Termination and mounting specifications  
 Detailed product/series data sheets  
 Hardware options per series

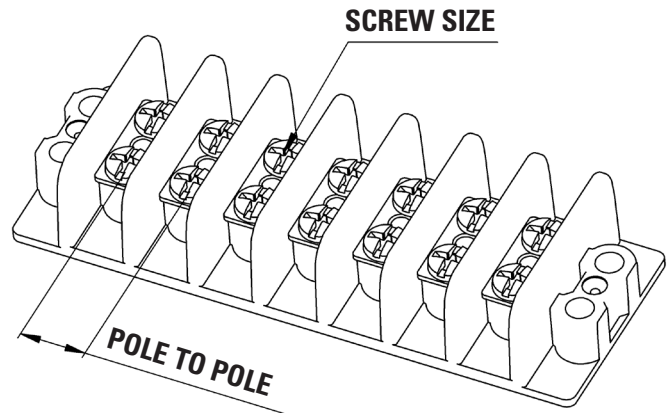

SERIES	AMPS	VOLTAGE CLASS B/C	BARE WIRE RANGE	MAX LUG WIDTH	SCREW SIZE	INCHES L TO L	POLES (xx)	WIDTH (INCHES)	HEIGHT (INCHES)	BASE MATERIAL	STYLE
670A RZ	20	300/150	#12-22	0.31	#6-32	0.375	1-30	0.87	0.48	Thermoplastic	Closed Back
621 RZ	30	600/600	#12-22	0.33	#6-32	0.437	1-30	1.38	0.75	Thermoplastic	Closed Back
671 RZ	30	300/150	#14-22	0.33	#6-32	0.437	1-30	1.13	0.53	Thermoplastic	Closed Back
672 RZ	30	600/600	#12-14	0.41	#8-32	0.562	1-24	1.31	0.71	Thermoplastic	Closed Back
670A GP (100)	20	250/NA	#12-22	0.30	#6-32	0.375	1-36	0.88	0.44	Phenolic	Closed Back
671 GP (200)	30	300/150	#14-22	0.34	#6-32	0.437	1-30	1.12	0.53	Phenolic	Closed Back
672 GP (300)	30	NA/600	#10-14	0.42	#8-32	0.562	1-24	1.31	0.71	Phenolic	Closed Back
400	30	NA/600	#10-22	0.47	#10-32	0.687	1-12	1.81	0.75	Phenolic	Closed Back
410	5	300/NA	#18-20	0.19	#2-56	0.25	1-23	0.63	0.32	Phenolic	Open Back
600	15	300/300	#14-22	0.30	#5-40	0.375	1-22	0.87	0.41	Phenolic	Open Back
600A	15	300/300	#12-22	0.30	#6-32	0.375	1-22	0.87	0.41	Phenolic	Open Back
601	20	300/300	#12-22	0.34	#6-32	0.437	1-23	1.13	0.50	Phenolic	Open Back
801	20	NA/150	#10	RIVET	#6-32	0.437	1-23	1.13	0.50	Phenolic	Open Back
602	30	300/300	#10-18	0.44	#8-32	0.562	1-26	1.32	0.64	Phenolic	Open Back
802	30	NA/150	#10	RIVET	#8-32	0.562	1-26	1.32	0.64	Phenolic	Open Back
603	50	600/600	#10-16	0.47	#10-32	0.687	1-12	1.81	0.75	Phenolic	Open Back
604	70	600/600	#10-14	0.58	#12-32	0.875	1-8	2.00	0.94	Phenolic	Open Back
605	90	600/600	#10-14	0.67	1/4-28	1.125	1-6	2.48	1.13	Phenolic	Open Back

# DOUBLE ROW ACCESSORIES

**DOUBLE ROW HARDWARE GENERAL OPTIONS** - see on-line product page for details and compatibility with each terminal block series.

## QUICK CONNECT (KT) OPTIONS:

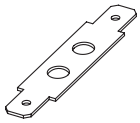

(2) 0° tabs

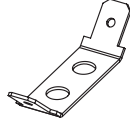

(2) 45° tabs

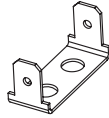

(2) 90° tabs

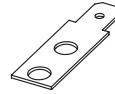

(1) 0° tab

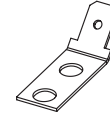

(1) 45° tab

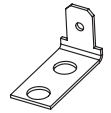

(1) 90° tab

## JUMPERS:

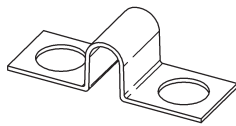

Pole to Pole

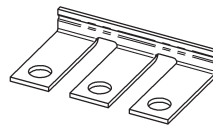

RJ

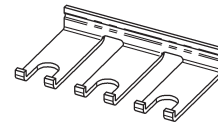

RJS

## SCREW & STUD OPTIONS:



Standard or "PSB"



"SEMS" or "SP"

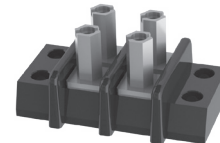

Stud Options

## SOLDER COMPONENTS - FEED-THRU AND OVER THE SIDE:

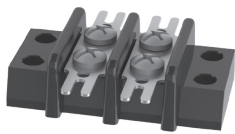

"ST"



"3/4 ST"



"Y"



"YSY"

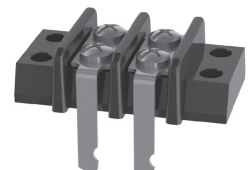

"Z"

## COVERS & MARKING STRIPS:

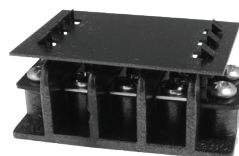
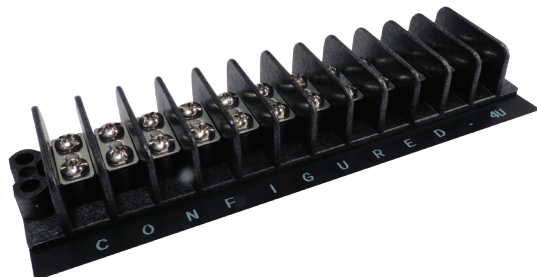

# SINGLE ROW TERMINAL BLOCKS

**SINGLE ROW TERMINAL BLOCKS** all consist of our classic open back, phenolic design that requires an additional insulator strip in order to achieve the noted voltage rating.

**ELECTRICAL:**

Amps & volts - see table

**STANDARDS:**

UL recognized file no. XCFR2.E47811  
 CSA certified file no. LR19766  
 CE compliant (IEC 60947-7-1)  
 RoHS compliant

**WEBSITE RESOURCES:**

Dimensional drawings & 3D CAD files  
 Termination and mounting specificatio  
 Detailed product/series data sheets  
 Hardware options per series

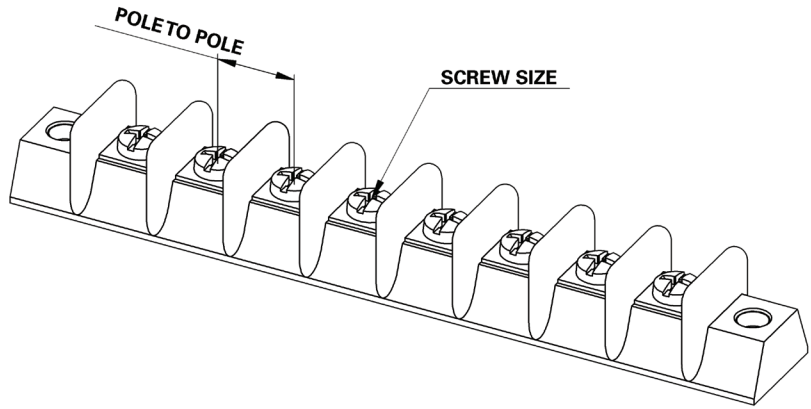

SERIES	AMPS	VOLTAGE CLASS B/C	BARE WIRE RANGE	MAX LUG WIDTH	SCREW SIZE	INCHES L TO L	# OF LINES	WIDTH (INCHES)	HEIGHT (INCHES)	BASE MATERIAL	STYLE
411	5	300/NA	#18-20	0.19	#2-56	0.25	1-23	0.41	0.31	Phenolic	Open Back
599	15	300/150	#16-22	0.30	#5-40	0.375	1-30	0.56	0.41	Phenolic	Open Back
799	15	NA/150	#14	RIVET	#5-40	0.375	1-30	0.56	0.41	Phenolic	Open Back
699	20	300/150	#14-20	0.33	#6-32	0.437	1-23	0.69	0.50	Phenolic	Open Back
899	20	NA/150	#14	RIVET	#6-32	0.437	1-23	0.69	0.50	Phenolic	Open Back
812	30	600/600	#12-14	0.41	#8-32	0.562	1-18	0.75	0.72	Phenolic	Open Back
912	30	NA/300	#10	RIVET	#8-32	0.562	1-18	0.75	0.72	Phenolic	Open Back

# SINGLE ROW ACCESSORIES

**SINGLE ROW HARDWARE GENERAL OPTIONS** - see on-line product page for details and compatibility with each terminal block series.

## QUICK CONNECT (KT) OPTIONS:

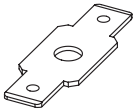

(2) 0° tabs



(2) 45° tabs

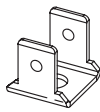

(2) 90° tabs

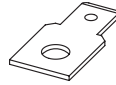

(1) 0° tab



(1) 45° tab



(1) 90° tab

## JUMPERS:

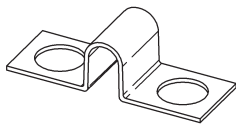

Pole to Pole

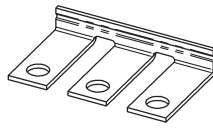

RJ

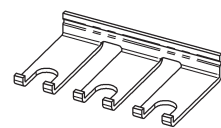

RJS

## SCREW & STUD OPTIONS:

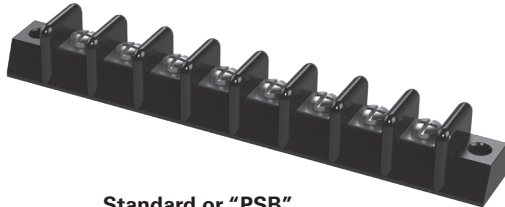

Standard or "PSB"



Stud Options

## SOLDER COMPONENTS - FEED-THRU AND OVER THE SIDE:

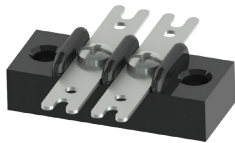

"ST"

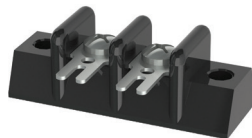

"3/4 ST"

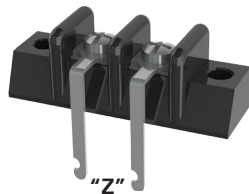

"Z"

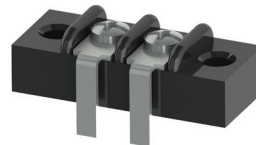

"1921"



"2204"

## MARKING STRIPS:

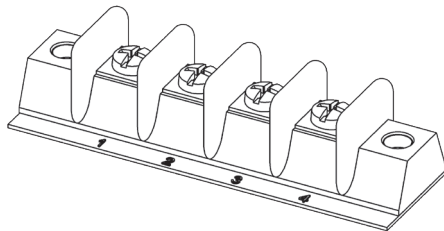

# MILITARY CLASS

## ELECTRICAL:

Amps & volts - see table

## STANDARDS:

Compliant to the A-A-59125

A-A-59125 superseded MIL-T-55164-C in 1997

These terminal blocks are constructed to meet both standards.

RoHS compliant (All)



39TB05F

## WEBSITE RESOURCES:

Detailed product data sheets

- Material information
- Termination & mounting specifications

Dimensional drawings & 3D CAD files

Accessories available

A-A-59125/ MIL-T-55164 INFORMATION		TERMINAL TYPE	VOLTAGE		AMPS	WIRE & LUG INFORMATION				
CLASS	SPEC #	DESCRIPTION	MAX RATED	DIELECTRIC WITH TEST	MAX RATED	SCREW SIZE	RECMD MAX WIRE SIZE	MS17143 LUG #	MAX LUG WIDTH	RECMD TORQUE Lb-In (N-M)
37 TB	/ 1	Double Screw	300 V RMS	3000 V RMS	15 Amp 60 Hz	#6	#16 AWG	-11	0.282" [7.2]	8-10 [0.9-1.1]
38 TB	/ 2	Double Screw	600 V RMS	3400 V RMS	20 Amp 60 Hz	#6	#14 AWG	-14	0.31" [7.9]	8-10 [0.9-1.1]
39 TB	/ 3	Double Screw	600 V RMS	4000 V RMS	30 Amp 60 Hz	#8	#10 AWG	-9	0.41" [10.4]	10-12 [1.1-1.4]
40 TB	/ 4	Single Screw Feed Thru	300 V RMS	3000 V RMS	7.5 Amp 60 Hz	#6	#18 AWG	-10	0.282" [7.2]	8-10 [0.9-1.1]
41 TB	/ 5	Single Screw Feed Thru	600 V RMS	3400 V RMS	10 Amp 60 Hz	#6	#16 AWG	-14	0.31" [7.9]	8-10 [0.9-1.1]
42 TB	/ 6	Single Screw Feed Thru	600 V RMS	4000 V RMS	15 Amp 60 Hz	#8	#14 AWG	-8	0.41" [10.4]	10-12 [1.1-1.4]

# NAVY CLASS

## ELECTRICAL:

Amps & volts - see table

## STANDARDS:

Compliant to the A-A-59125

A-A-59125 superseded MIL-T-55164-C in 1997.

These terminal blocks are constructed to meet both standards.

RoHS compliant (All)

## WEBSITE RESOURCES:

Detailed product data sheets

- Material information
- Termination & mounting specifications

Dimensional drawings & 3D CAD files

Accessories available

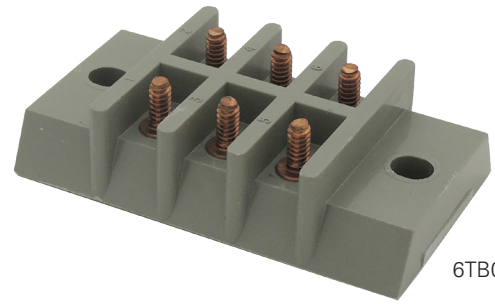

6TB06F

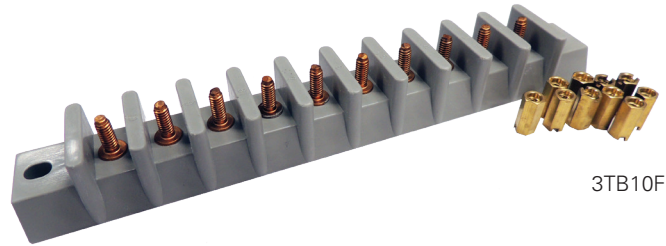

3TB10F

A-A-59125/ MIL-T-55164 INFORMATION		TERMINAL TYPE	VOLTAGE		AMPS	WIRE & LUG INFORMATION				
CLASS	SPEC #	DESCRIPTION	MAX RATED	DIELECTRIC WITH TEST	MAX RATED	SCREW SIZE	RECMD MAX WIRE SIZE	MS17143 LUG #	MAX LUG WIDTH	RECMD TORQUE Lb-In (N-M)
3TB	/ 9	Single Stud Single Row	600V RMS	2000V RMS	45 Amp 60 Hz	#8	#10 AWG	-3	0.395" [10.0]	16-18 [1.8-2.0]
4 TB	/ 10	Single Stud Double Row	600 V RMS	2200 V RMS	40 Amp 60 Hz	#8	#12 AWG	-3	0.395" [10.0]	16-18 [1.8-2.0]
5 TB	/ 11	Feed Thru Stud Single Row	600 V RMS	2200 V RMS	50 Amp 60 Hz	#8	#10 AWG	-3	0.395" [10.0]	16-18 [1.8-2.0]
6 TB	/ 12	Single Stud Double Row	600 V RMS	2200 V RMS	30 Amp 60 Hz	#6	#14 AWG	-5	0.307" [7.8]	10-12 [1.1-1.4]
7 TB	/ 13	Feed Thru Stud Single Row	600 V RMS	2200 V RMS	40 Amp 60 Hz	#6	#12 AWG	-6	0.307" [7.8]	10-12 [1.1-1.4]
8 TB	/ 14	Double Stud Double Row	300 V RMS	1500 V RMS	30 Amp 60 Hz	#5	#14 AWG	-11	0.282" [7.2]	8-10 [0.9-1.1]
9 TB	/ 15	Single Stud Single Row	300 V RMS	1500 V RMS	35 Amp 60 Hz	#6	#12 AWG	—	0.307" [7.8]	10-12 [1.1-1.4]
10 TB	/ 16	Single Stud Double Row	600 V RMS	2200 V RMS	30 Amp 60 Hz	#6	#14 AWG	—	0.242" [6.11]	10-12 [1.1-1.4]
11 TB	/ 17	Feed Thru Stud Single Row	600 V RMS	2200 V RMS	40 Amp 60 Hz	#6	#12 AWG	-15	0.242" [6.1]	10-12 [1.1-1.4]
15 TB	/ 19	Single Stud Double Row	600 V RMS	2200 V RMS	30 Amp 60 Hz	#8	#14 AWG	-8	0.307" [7.8]	16-18 [1.8-2.0]
16 TB	/ 20	Single Stud Double Row	1000 V RMS	3000 V RMS	40 Amp 60 Hz	#8	#12 AWG	-3	0.395" [10.0]	16-18 [1.8-2.0]
17 TB	/ 21	Double Stud Double Row	600 V RMS	2200 V RMS	40 Amp 60 Hz	#6	#12 AWG	-3	0.395" [10.0]	10-12 [1.1-1.4]
25 TB	/ 23	Single Stud Single Row	300 V RMS	1500 V RMS	25 Amp 60 Hz	#4	#14 AWG	-17	0.242" [6.1]	6-8 [0.7-0.9]
26 TB	/ 24	Double Stud Double Row	300 V RMS	1500 V RMS	20 Amp 60 Hz	#4	#16 AWG	-20	0.242" [6.1]	6-8 [0.7-0.9]

# SECTIONAL TERMINAL BLOCKS

## DIN (EURO-STYLE) SECTIONAL TERMINAL BLOCKS

### ELECTRICAL:

Insulating material:

- Nylon- 6/6, grey
- UL 94V-2 flammability rating
- 100° C / 212° F continuous, 170° C / 338° F intermittent & short exposure

Connector - copper, nickel plated

Screws - steel, zinc plated

Integrated pressure plate to avoid wire damage

For identification labels - see page 42

### STANDARDS:

UL recognized file no. XCFR2.E62806

CSA certified file no. LR700930

VDE

CE compliant

RoHS compliant

CATALOG #	WIRE RANGE	AMPS			VOLTS	DIMENSIONS (MM)			TERMINALS PER FOOT	TERMINAL TORQUE	DESCRIPTION
		UL	CSA	VDE		T	W	H			
MIK3	#12-#22 AWG	20	25	26	600	5	42	36	60	5	Terminal
MIK5	#10-#22 AWG	30	25	24	600	6	42	38	50	9 - 13.3	Terminal
MIK10	#8-#22 AWG	50	50	61	600	8	42	44	38	9.8	Terminal
MIK16	#6-#22 AWG	65	68	82	600	10	42	44	30	18	Terminal
MIK25	#4-#8 AWG	85	70	108	600	12	50	48	25	27	Terminal
MIKTS4	#12-#22 AWG	20	20	16	300	6	42	53	50	-	Disconnect
MIKSI5	#10-#20 AWG	10	-	6	300	8	60	47	38	-	Fused Terminal <sup>1</sup>
MIKE4	#10-#22 AWG	-	-	-	-	7	56	38	-	8.0	Grounding Lug <sup>2</sup>
MIKE10	#8 AWG	-	-	-	-	8	56	44	-	13.3	Grounding Lug <sup>2</sup>
MIKE16	#6 AWG	-	-	-	-	10	56	44	-	18	Grounding Lug <sup>2</sup>

<sup>1</sup> UL File No. E35113, For Fuse Type - 5x20 or 5x25 mm

<sup>2</sup> Grounding Lugs are Green/Yellow Nylon

Dimensions:  
 H = Height  
 W = Width  
 T = Thickness

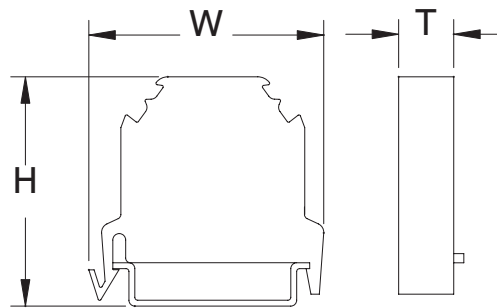

Terminal  
(MIK5)

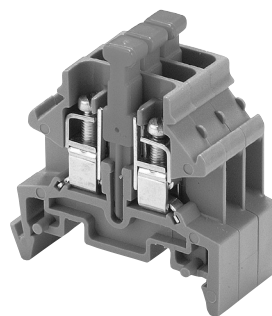

Disconnect Terminal  
(MIKTS4)

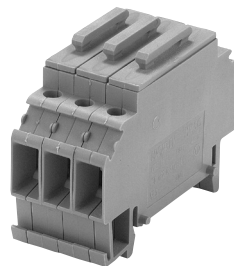

Fused Terminal  
(MIKSI5)

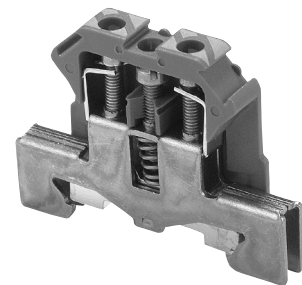

Grounding Lug  
(MIKE10)



# SECTIONAL TERMINAL BLOCKS

## DIN (EURO-STYLE) SECTIONAL TERMINAL BLOCKS HARDWARE

**Insulating end sections** - cover the last terminal of an assembly

**Insulating partitions** - for visual and electrical separation of terminals grouped on DIN rail

**2-position jumpers** - connect two adjacent terminals (middle portion snaps off to assemble)

**12-position jumpers** - connect up to 12 adjacent terminals (middle portion snaps off to assemble); jumper can be easily cut to length to connect smaller assemblies

**Connecting strap** - for linking two adjacent 12-pole jumpers

**Safety cover** - cover with warning label for line terminals which cannot be disconnected

**End brackets** - anchor on both ends of terminal assemblies to hold the assembly in place

**DIN rail** - standard 35 x 7.5 mm DIN rail, cut in 2 meter lengths with slots for mounting (steel, zinc plated)

	MIK3	MIK5	MIK10	MIK16	MIK25	MIKTS4	MIKS15
Insulating End Sections	MIW2	MIW4	MIW16	MIW16	MIW50	MIW4	-
Insulating Partitions	MIW4	MIW16	MIW50	MIW50	MIW70	-	MIW50
2-Position Jumper	MVB2-2	MVB4-2	MVB6-2	MVB16-2	MVB25	-	-
12-Position Jumper	MVB2-12	MVB4-12	MVB6-12	MVB16-12	-	-	-
Connecting Strap	MVL2-2	MVL4-2	MVL6-2	MVL16-2	MVL25	-	-
Safety Cover	MKAW2	MKAW2	MKAW10	MKAW16	MKAW25	-	-
End Bracket/Anchor <sup>1</sup>	MSK35	MSK35	MSK35	MSK35	MSK35	MSK35	MSK35
DIN Rail	MN35-2	MN35-2	MN35-2	MN35-2	MN35-2	MN35-2	MN35-2

<sup>1</sup>MSK35 - End Bracket Securing Torque 7-9 lb-in (.8-1 N-m)

### UNIVERSAL IDENTIFICATION LABELS TYPE MSH SPECIFICATIONS:

Available plain, with numbers, letters or symbols

Can be labeled vertically or horizontally

Single label MSH 5 can be used for all sizes

MSH5 & MSH6 are sold in ten strips of ten

MSH8 & MSH10 are sold in ten strips of five

RoHS compliant



### ORDERING CODE:

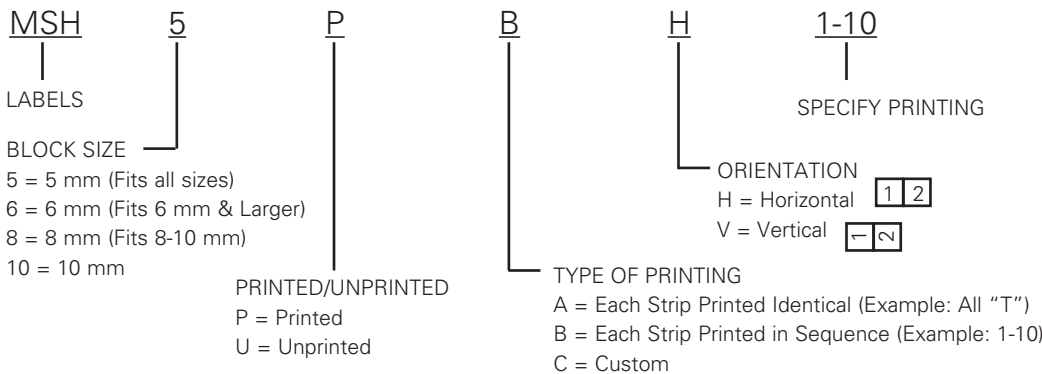

# SECTIONAL TERMINAL BLOCKS

## 3/8" SECTIONAL CHANNEL (C), FLAT (F), & DIN MOUNT

### ELECTRICAL:

See table

### STANDARDS:

UL recognized file no. XCFR2.E62806 or E47811  
 CSA certified file no. LR19766 (CSA C22-2 No. 158)  
 CE (Component IEC 60947-7-1)  
 RoHS compliant (All)

### WEBSITE RESOURCES:

Dimensional drawings & 3D CAD files  
 Termination and mounting specifications  
 Detailed product/series data sheets

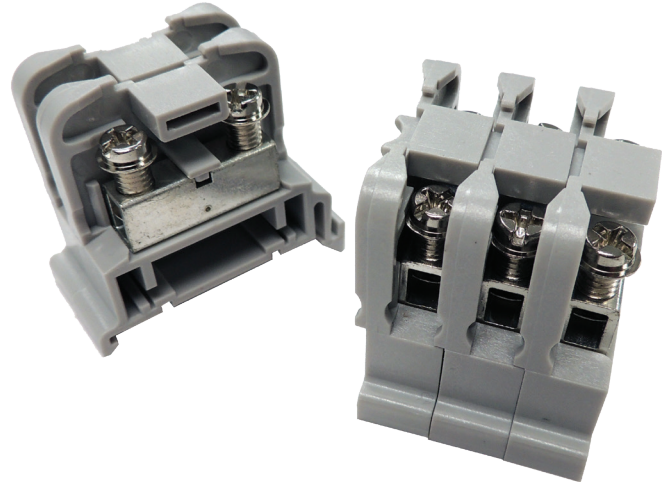

6G38 TSKK DIN

### 6G38 TS - TUBULAR SCREW CONNECTOR

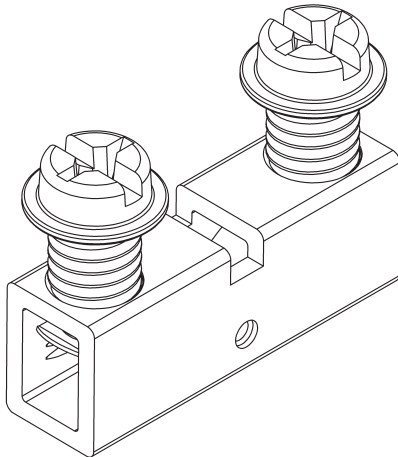

### ELECTRICAL AND WIRE RANGE INFO:

50 amps (40 amps CSA)  
 32 circuits per foot  
 Single and multiple wire combinations:

<u>Stranded CU</u>	<u>Solid CU</u>
(1) #8 - #18 AWG	(1) #10 - #16 AWG
(1-3) #12 AWG	(1-3) #12 AWG
(1-4) #14 AWG	(1-4) #14 or #16 AWG

CATALOG #	DESCRIPTION	STD PK
6G38 TS F	Flat mount block	100
6G38 TS C	Channel mount block	100
6G38 TS DIN	DIN mount block	25

### 6G38 TSKK - TS WITH WIRE PROTECTOR CONNECTOR

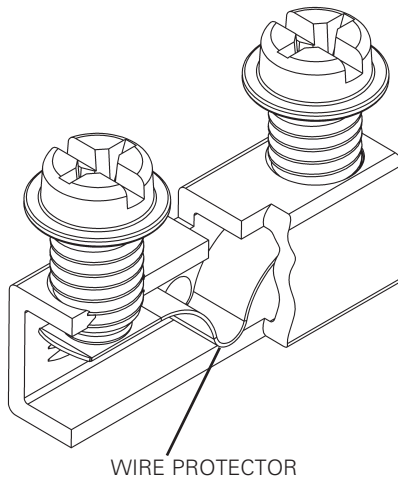

### ELECTRICAL AND WIRE RANGE INFO:

40 amps  
 32 circuits per foot  
 Single and multiple wire combinations:

<u>Stranded CU</u>	<u>Solid CU</u>
(1) #10 - #22 AWG	(1) #10 - #14 AWG
(1-2) #12 AWG	(1-2) #12 or #14 AWG
(1-3) #14 AWG	
(1-4) #16 AWG	
(1-5) #18 or #22 AWG	

CATALOG #	DESCRIPTION	STD PK
6G38 TSKK F	Flat mount block	100
6G38 TSKK C	Channel mount block	100
6G38 TSKK DIN	DIN mount block	25

# SECTIONAL TERMINAL BLOCKS

## ACCESSORIES:

CATALOG #	DESCRIPTION	IMAGE	STD PACK
J 38	Jumper for TS and TSKK		50
MC	Mounting Clamp (For channel style only)		25
MS 2	Vinyl Marking Strip (1/2" x 2' white)		25
MN35-2	DIN Rail, 35 x 7.5 mm 2 m long, slotted		25
MSK35	End bracket for DIN mount base		25
6G38 E C 6G38 E F 6G38 E DIN	End bracket for 6G38 versions		25
MPC-3 (3 ft channel) MPC-6 (6 ft channel)	Channel		1

## DIMENSIONS - 6G38 TS & TSKK

### CHANNEL MOUNT

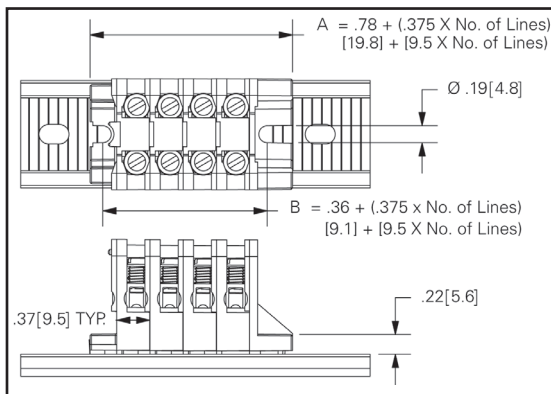

### FLAT MOUNT

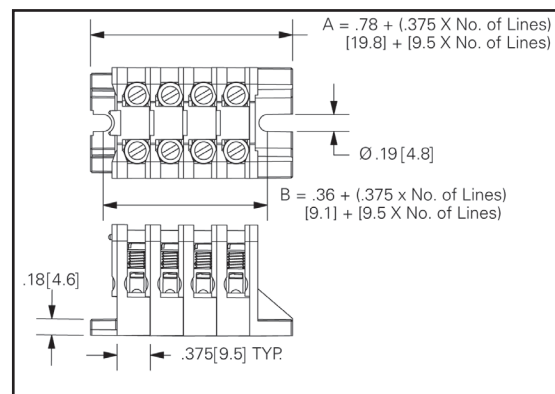

### DIN MOUNT

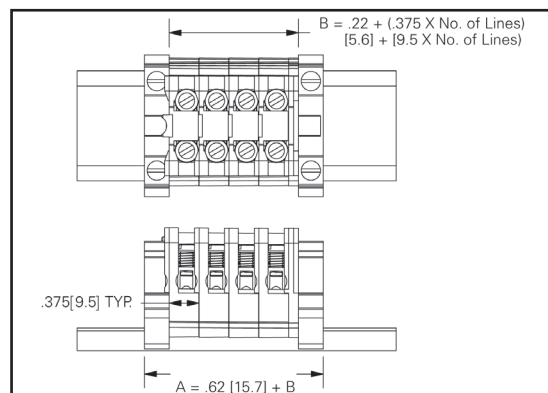

# SECTIONAL TERMINAL BLOCKS

## 1/2" SECTIONAL TERMINAL BLOCK

### ELECTRICAL:

70 amps, 600 volts  
 10 kA SCCR  
 24 circuits per foot  
 Bare wire range #4 - #16 AWG Copper

### STANDARDS:

UL recognized file no. XCFR2.E62806  
 CSA certified file no. LR19766  
 CE compliant  
 RoHS compliant

### WEBSITE RESOURCES:

Dimensional drawings & 3D CAD files  
 Termination and mounting specifications  
 Detailed product/series data sheets

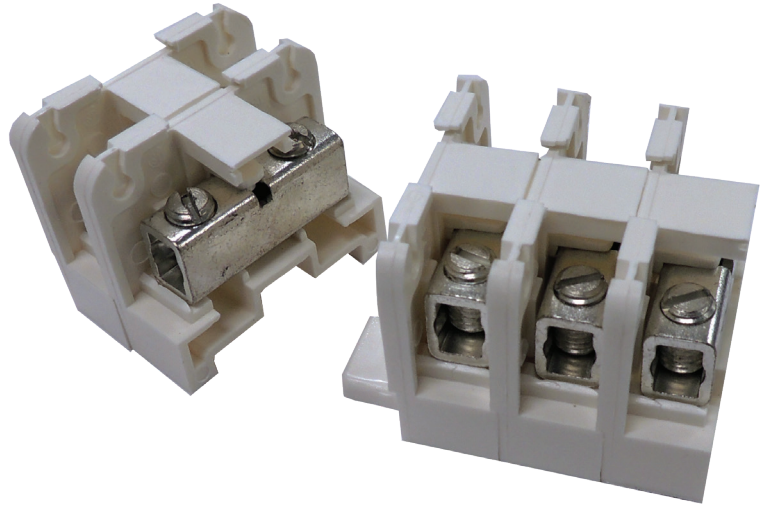

6H12 TSCU F

### ACCESSORIES:

CATALOG #	DESCRIPTION	IMAGE	STD PK
6H12 TSCU F For flat mount block	Tubular Screw		50
6H12 TSCU C For channel mount block	Tubular Screw		50
6H12 E F For flat mount block	End Section		25
6H12 E C For channel mount block	End Section		25
J 12	Jumper		50
MC	Mounting Clamp		25
MPC-3 (3 ft channel) MPC-6 (6 ft channel)	Channel		--
MS 2	Vinyl Marking Strip - 1/2" x 2'		25