

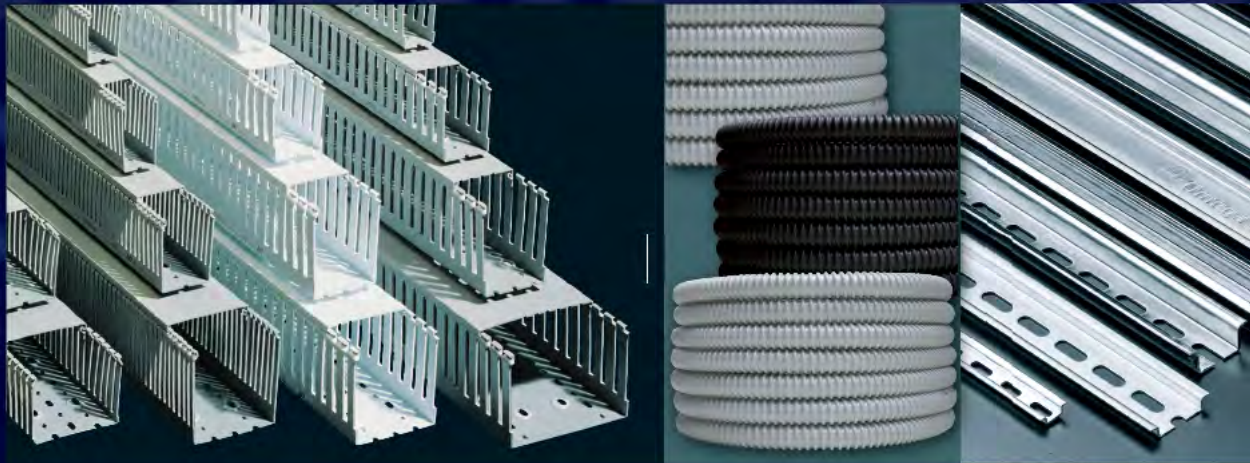

IBOCO®

IBO

25 Years in business



Integrated Panel Management





IBOCO CORPORATE PROFILE

Since 1986 the IBOCO Corporation, located in New Jersey, has led Italy-based Bocchiotti Group's marketing operations in the United States.

BOCCHIOTTI CORPORATE PROFILE

Founded in 1965, IBOCO parent Company BOCCHIOTTI is widely recognized throughout the world as one of the major manufacturers of wire management products, raceways and conduits.

The Bocchiotti Group with about 500 employees is headquartered in Genoa, Italy and has production plants and warehouses in 8 different locations throughout the Country.

The fully automated systems enable the Company to produce over 180 million feet of wiring duct and raceway per year in 25 different product lines which are distributed in 42 Countries.

High Standard Products for Advanced and Time-Saving Panel Assembling

Every item in the rapidly expanding product line is designed and produced to meet the needs of original equipment manufacturers, installers, panel builders, and system integrators and complies with UL, CSA, CE and most international certifications. IBOCO's extensive catalog features several product lines: DIN rail, DIN rail accessories, T1 slotted duct, T1-E slotted duct, T1-K black slotted duct, T1-B blue slotted duct, TS/TSH solid duct, DINOSAUR flexible duct, cable ties and attachments, Spiralite, braided expandable sleeveings, installation tools and over 40 accessories. The Company's integrated panel management systems continue to evolve and grow to meet the changing needs of panel builders. However, its overriding philosophy remains unchanged: to simplify and accelerate panel building operations including wire identification, retention and separation for panel builders, OEMs', and system integrators in a variety of industries.

A Very Extensive Line of Wiring Duct and Components

IBOCO offers an integrated system of specific solutions for panel builders' needs.

This duct system features 5 styles of duct with up to 35 duct sizes, a complete line of Din rails, and over 40 components and accessories. This combination allows for the simplification and acceleration of panel building operations such as wire retention, identification of equipment/circuits, circuit/wire separation, and the direct mounting of duct and equipment on Din rails.

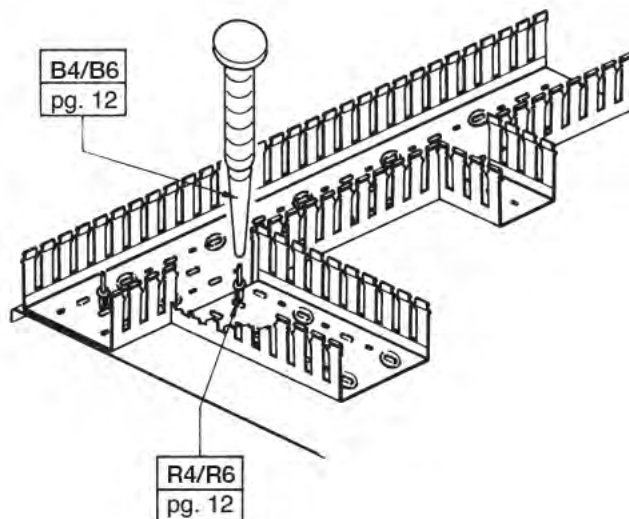
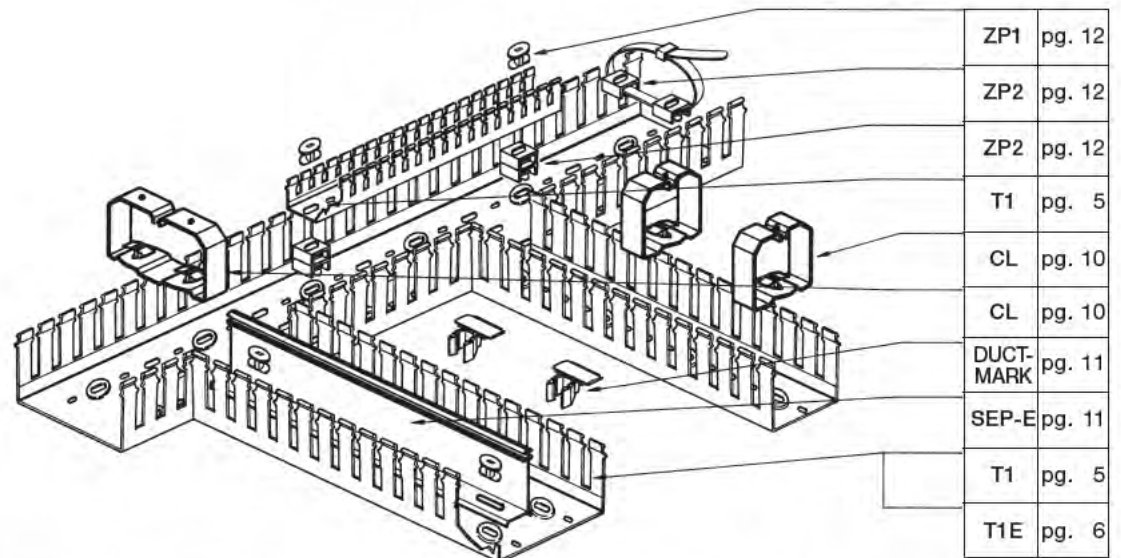

The IBOCO duct system

simplifies and decreases the time required for the planning and construction of control panels by offering the ability to:

- contain the wires
- identify the switchgear
- mount the wiring duct directly onto mounting rail or internal mounting plate
- build the frame of the panel board
- retain the wires
- achieve extremely compact wiring configurations
- separate circuits with different voltages and/or functions
- form wire bundles

Table of Contents

Wiring duct series	5-9
Wiring duct covers	8
Wire Retainers	10
Wiring Duct Separators	11
Identification Tag	11
Wiring Duct Rivets	12
Cable Tie Attachments	12
Dinosaur “Flexible Duct” (New White)	13
Spiralite	14
Sleeving – Expandable Polyester (New)	14
Din Mounting Rails (New Aluminum)	15
Din Rail Mounting Clips	16
Din Rail Support Brackets	16
Din Rail Mounting Blocks	17
Din Rail-Duct Support Arms	17
Wire Fill Capacity T1/T1-E/T1H/T1EH	18
Tools	19
Cable Ties	20-21
Cable Mounts	21
Liquidtight conduit	22
Adhesive Backed Duct	23
Technical Characteristics of Materials	24
Chemical Resistant Properties of PVC	25

Alphabetical Index of Catalog Numbers

Catalog Number	Page	Catalog Number	Page
B4	12	R4	12
B6	12	R6N	12
BL-120	19	R60	12
CL	10	RPS	22
COV	8	RT4 - RT6	12
CUR	22	SEP-E	11
DC-510	19	ST	16
DCA-100	19	STS	16
DINBLOK	17	SX-15	19
DINFIX	16	SX-15B	19
DM	11	T1	5
DN-A	13	T1-B	7
G1	15	T1-E	6
GT	22	T1-K	7
GSI	22	TY	14
ICT	20-21	TR1	10
IG-11	15	TR1-E	10
ITT-1	19	TS / TSH	8
ITT-2A	19	WT-2	19
OMEGA	15	WT-2B	19
P-PA (SPIRALITE)	14	ZP1	12
		ZP2	12



T1

DUCT SERIES

Material

Rigid PVC,
self-extinguishing

Color

Light GREY RAL 7030
WHITE

Standard Length

6 Feet 6 3/4 Inches

Standard Unit

Duct complete
with cover

THE MOST COMPREHENSIVE RANGE

NOMINAL 1 1/2"-2 1/4"-3"-4"

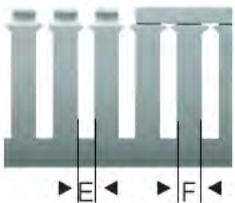

NOMINAL 5/8"-1"



All wiring ducts come complete with cover. Wiring duct covers can be sold separately: see page 8 and IBOCO Corp. Price List.

Catalog Number	Nominal Size (WxH)	Dimensions in inches (Actual)				Dimensions WxH (in millimeters)	Standard Carton (Qty)	
		W	H	E	F		Lengths (1)	Feet
T1-0506G	1/2 x 5/8	.60	.71	.20	.30	15 x 18	20	120
T1-0510G	1/2 x 1	.60	1.18	.20	.30	15 x 30	20	120
T1-0522G	1/2 x 2 1/4	.60	2.36	.20	.30	15 x 60	16	96
T1-1010*	1 x 1	1.00	1.18	.20	.30	25 x 30	18	108
T1-1015*	1 x 1 1/2	1.00	1.57	.31	.47	25 x 40	18	108
T1-1022*	1 x 2 1/4	1.00	2.36	.31	.47	25 x 60	24	144
T1-1030*	1 x 3	1.00	3.15	.31	.47	25 x 80	24	144
T1-1040*	1 x 4	1.00	3.94	.31	.47	25 x 100	8	48
T1-1515*	1 1/2 x 1 1/2	1.57	1.57	.31	.47	40 x 40	20	120
T1-1522*	1 1/2 x 2 1/4	1.57	2.36	.31	.47	40 x 60	18	108
T1-1530*	1 1/2 x 3	1.57	3.15	.31	.47	40 x 80	16	96
T1-1540*	1 1/2 x 4	1.57	3.94	.31	.47	40 x 100	8	48
T1-2215G	2 1/4 x 1 1/2	2.36	1.57	.31	.47	60 x 40	12	72
T1-2222*	2 1/4 x 2 1/4	2.36	2.36	.31	.47	60 x 60	12	72
T1-2230*	2 1/4 x 3	2.36	3.15	.31	.47	60 x 80	12	72
T1-2240*	2 1/4 x 4	2.36	3.94	.31	.47	60 x 100	4	24
T1-3015G	3 x 1 1/2	3.15	1.57	.31	.47	80 x 40	12	72
T1-3022*	3 x 2 1/4	3.15	2.36	.31	.47	80 x 60	12	72
T1-3030*	3 x 3	3.15	3.15	.31	.47	80 x 80	12	72
T1-3040*	3 x 4	3.15	3.94	.31	.47	80 x 100	4	24
T1-3050*	3 x 5	2.95	4.92	.31	.47	75 x 125	6	36
T1-4015G	4 x 1 1/2	3.94	1.57	.31	.47	100 x 40	8	48
T1-4022G	4 x 2 1/4	3.94	2.36	.31	.47	100 x 60	8	48
T1-4030*	4 x 3	3.94	3.15	.31	.47	100 x 80	8	48
T1-4040*	4 x 4	3.94	3.94	.31	.47	100 x 100	4	24
T1-4050*	4 x 5	3.94	4.92	.31	.47	100 x 125	4	24
T1-6040*	6 x 4	5.91	3.94	.31	.47	150 x 100	4	24

Example: T1-0510 G = 1/2"x 1"light GREY duct with cover

(1) Each standard length is actually 6'6 3/4" but is counted as 6 feet for packaging and pricing

* Color - add suffix "G" for light GREY "W" for WHITE

ADHESIVE BACKING - add suffix "A" to catalog number - contact sales office for pricing (see page 23)

Available in 1 meter length contact sales office

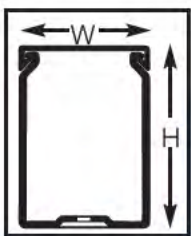

Non-slip cover design of minimum encumbrance and maximum grip.



Restricted slot opening for wire retaining.



Two predetermined breaklines:
- for breaking off and removal of sidewall finger segments only.
- for removal of sidewall finger and base segments.



Burr-free edges.

Recess boss for rapid mounting of components.

For wire fill capacity and base perforation of the wiring duct, see page 18.

T1-E

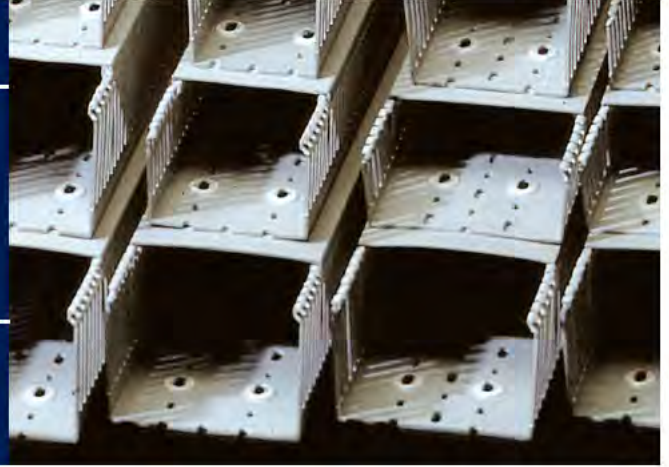

DUCT SERIES

Material

Rigid PVC,
self-extinguishing

Color

Light GREY RAL 7030
WHITE

Standard Length

6 Feet 6 3/4 Inches

Standard Unit

Duct complete
with cover

Catalog Number	Nominal Size (WxH)	Dimensions in inches (Actual)				Dimensions WxH (in millimeters)		Standard Carton (Qty)	
		W	H	E	F	Lengths (1)	Feet		
T1E-1015*	1 x 1½	1.00	1.57	.16	.24	25 x 40	18	108	
T1E-1022*	1 x 2¼	1.00	2.36	.16	.24	25 x 60	24	144	
T1E-1030*	1 x 3	1.00	3.15	.16	.24	25 x 80	24	144	
T1E-1040*	1 x 4	1.00	3.94	.16	.24	25 x 100	8	48	
T1E-1515*	1½ x 1½	1.57	1.57	.16	.24	40 x 40	20	120	
T1E-1522*	1½ x 2¼	1.57	2.36	.16	.24	40 x 60	18	108	
T1E-1530*	1½ x 3	1.57	3.15	.16	.24	40 x 80	16	96	
T1E-1540*	1½ x 4	1.57	3.94	.16	.24	40 x 100	8	48	
T1E-2215G	2¼ x 1½	2.36	1.57	.16	.24	60 x 40	12	72	
T1E-2222*	2¼ x 2¼	2.36	2.36	.16	.24	60 x 60	12	72	
T1E-2230*	2¼ x 3	2.36	3.15	.16	.24	60 x 80	12	72	
T1E-2240*	2¼ x 4	2.36	3.94	.16	.24	60 x 100	4	24	
T1E-3015G	3 x 1½	3.15	1.57	.16	.24	80 x 40	12	72	
T1E-3022*	3 x 2¼	3.15	2.36	.16	.24	80 x 60	12	72	
T1E-3030*	3 x 3	3.15	3.15	.16	.24	80 x 80	12	72	
T1E-3040*	3 x 4	3.15	3.94	.16	.24	80 x 100	4	24	
T1E-4015G	4 x 1½	3.94	1.57	.16	.24	100 x 40	8	48	
T1E-4022G	4 x 2¼	3.94	2.36	.16	.24	100 x 60	8	48	
T1E-4030*	4 x 3	3.94	3.15	.16	.24	100 x 80	8	48	
T1E-4040*	4 x 4	3.94	3.94	.16	.24	100 x 100	4	24	

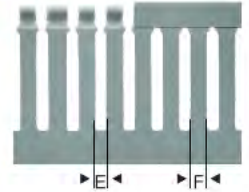

Example: T1E-1015 G = 1"x1½" light GREY duct with cover

Available in 1 meter length
contact sales office

(1) Each standard length is actually 6'6 3/4"
but is counted as 6 feet for packaging and pricing

* Color - add suffix "G" for light GREY "W" for WHITE

ADHESIVE BACKING - add suffix "A" to catalog number -
contact sales office for pricing (see page 22)

All wiring ducts come
complete with cover.
Wiring duct covers can
be sold separately;
see page 8 and
IBOCO Corp. Price List.

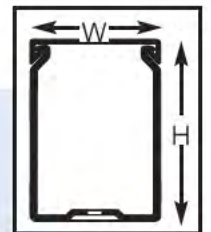

Restricted slot
opening for
wire
retaining.

Two predetermined
breaklines:
- for breaking off and
removal of sidewall
finger segments only.
- for removal of sidewall
finger and base segments.

Burr-free edges.

Recess boss for rapid
mounting
of components.

Non-slip cover
design of minimum
encumbrance and
maximum grip.

For wire fill capacity and base perforation of the wiring duct, see page 18.



T1-K

DUCT SERIES

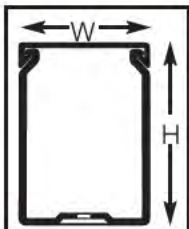

Catalog Number	Nominal Size (WxH)	Dimensions in inches (Actual)				Dimensions WxH (in millimeters)	Standard Carton (Qty)	
		W	H	E	F		Lengths (1)	Feet
T1-1040K	1 x 4	1.00	3.94	.31	.47	25x100	8	48
T1-1530K	1½ x 3	1.57	3.15	.31	.47	40x 80	16	96
T1-2222K	2¼ x 2¼	2.36	2.36	.31	.47	60x 60	12	72
T1-2240K	2¼ x 4	2.36	3.94	.31	.47	60x100	4	24
T1-3030K	3 x 3	3.15	3.15	.31	.47	80x 80	12	72
T1-3040K	3 x 4	3.15	3.94	.31	.47	80x100	4	24
T1-3050K	3 x 5	2.95	4.92	.31	.47	75x125	6	36
T1-4040K	4 x 4	3.94	3.94	.31	.47	100x100	4	24
T1-4050K	4 x 5	3.94	4.92	.31	.47	100x125	4	24

For special sizes contact sales office

Material

Rigid PVC, self-extinguishing

Color

BLACK

Standard Length

6 Feet 6 3/4 Inches

Standard Unit

Duct complete with cover

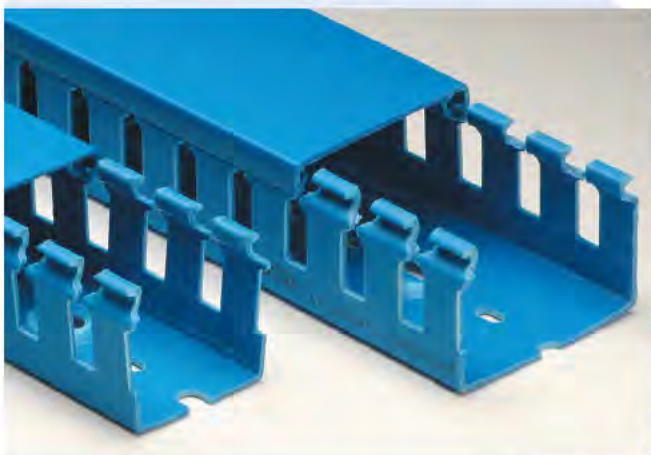

T1-B

Material

Rigid PVC, self-extinguishing

Color

BLUE RAL 5015

Standard Length

6 Feet 6 3/4 Inches

Standard Unit

Duct complete with cover

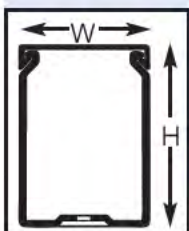

Catalog Number	Nominal Size (WxH)	Dimensions in inches (Actual)				Dimensions WxH (in millimeters)	Standard Carton (Qty)	
		W	H	E	F		Lengths (1)	Feet
T1-1010B	1 x 1	1.00	1.18	.20	.30	25x 30	18	108
T1-1022B	1 x 2¼	1.00	2.36	.31	.47	25x 60	24	144
T1-1030B	1 x 3	1.00	3.15	.31	.47	25x 80	24	144
T1-1515B	1½ x 1½	1.57	1.57	.31	.47	40x 40	20	120
T1-1522B	1½ x 2¼	1.57	2.36	.31	.47	40x 60	18	108
T1-1530B	1½ x 3	1.57	3.15	.31	.47	40x 80	16	96
T1-2215B	2¼ x 1½	2.36	1.57	.31	.47	60x 40	12	72
T1-2222B	2¼ x 2¼	2.36	2.36	.31	.47	60x 60	12	72
T1-2230B	2¼ x 3	2.36	3.15	.31	.47	60x 80	12	72
T1-3030B	3 x 3	3.15	3.15	.31	.47	80x 80	12	72
T1-3050B	3 x 5	2.95	4.92	.31	.47	75x 125	6	36
T1-4030B	4 x 3	3.94	3.15	.31	.47	100x 80	8	48
T1-4040B	4 x 4	3.94	3.94	.31	.47	100x100	4	24

Blue color duct recognized for intrinsic safe circuits

NOTE : 1) Each standard length is 6' 6¾" but is considered as 6 feet for the purpose of pricing and packaging.

TS / TSH

DUCT SERIES



Material

Rigid PVC,
self-extinguishing

Color

Light GREY RAL 7030

Standard Length

6 Feet 6 3/4 Inches

6 Feet 6 3/4 Inches

Standard Unit

Duct complete
with cover

Catalog Number	Nominal Size (WxH)	Dimensions in inches (Actual)		Dimensions WxH (in millimeters)	Standard Carton (Qty)	
		W	H		Lengths (1)	Feet
TS/TSH-0506G	1/2 x 5/8	.60	.71	15x 18	20	120
TS/TSH-0510G	1/2 x 1	.60	1.18	15x 30	20	120
TS/TSH-1010G	1 x 1	1.00	1.18	25x 30	18	108
TS/TSH-1015G	1 x 1 1/2	1.00	1.57	25x 40	18	108
TS/TSH-1030G	1 x 3	1.00	3.15	25x 80	24	144
TS/TSH-1515G	1 1/2 x 1 1/2	1.57	1.57	40x 40	20	120
TS/TSH-1522G	1 1/2 x 2 1/4	1.57	2.36	40x 60	18	108
TS/TSH-1530G	1 1/2 x 3	1.57	3.15	40x 80	16	96
TS/TSH-2222G	2 1/4 x 2 1/4	2.36	2.36	60x 60	12	72
TS/TSH-2230G	2 1/4 x 3	2.36	3.15	60x 80	12	72
TS/TSH-3022G	3 x 2 1/4	3.15	2.36	80x 60	12	72
TS/TSH-3030G	3 x 3	3.15	3.15	80x 80	12	72
TS/TSH-3040G	3 x 4	3.15	3.94	80x100	4	24
TS/TSH-4030G	4 x 3	3.94	3.15	100x 80	8	48
TS/TSH-4040G	4 x 4	3.94	3.94	100x100	4	24

Optional adhesive backing available: add suffix "A" to catalog number.
Contact the IBOCO sales office for pricing (see page 23).

TS - Solid duct
less mtg. holes

TSH - Solid duct
with mtg. holes

COV/COV-H

COV COVER FOR T1 / T1-E / TS / TSH

Material

Rigid PVC,
self-extinguishing

Color

Light GREY RAL 7030
WHITE

COV-H COVER FOR T1H / T1EH

Material

Halogen Free

Color

Light GREY RAL 7035



Catalog Number	Standard Carton Lengths (1)	Standard Carton (Qty.) Feet
COV-05*	25	150
COV-10*	25	150
COV-15*	25	150
COV-22*	25	150
COV-30*	25	150
COV-40*	20	120
COV-60*	20	120

* Color - add suffix "G" for light GREY RAL 7030
"W" for WHITE
For blue or black covers contact sales office

(1) Each standard length is actually 6' 6 3/4" but is counted as 6 feet for packaging and pricing

Catalog Number	Standard Carton Lengths (1)	Standard Carton (Qty.) Feet
COV-10H	10	60
COV-15H	10	60
COV-20H	10	60
COV-30H	10	60
COV-40H	10	60

(1) Each standard length is actually 6' 6 3/4" but is counted as 6 feet for packaging and pricing

**CONSULT
FACTORY**



T1H

HALOGEN FREE WIRING DUCT: STANDARD FINGER

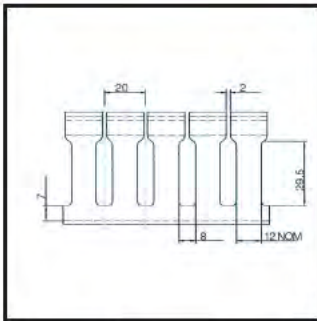

Measurements

Catalog Number	Size (w x h)	Size (Millimeters)	Standard Carton (Feet)
T1H-1020LG*	1 x 2	25 x 50	72
T1H-1030LG*	1 x 3	25 x 75	72
T1H-1515LG	1½ x 1½	37.5 x 37.5	72
T1H-1520LG*	1½ x 2	37.5 x 50	72
T1H-1530LG	1½ x 3	37.5 x 75	72
T1H-2020LG*	2 x 2	50 x 50	72
T1H-2030LG*	2 x 3	50 x 75	72
T1H-2040LG*	2 x 4	50 x 100	48
T1H-3020LG	3 x 2	75 x 50	72
T1H-3030LG*	3 x 3	75 x 75	48
T1H-3040LG*	3 x 4	75 x 100	24
T1H-4020LG	4 x 2	100 x 50	48
T1H-4030LG	4 x 3	100 x 75	48
T1H-4040LG	4 x 4	100 x 100	24

LG = LIGHT GREY RAL 7035

*CURRENTLY AVAILABLE

**Except T1H-4030LG Service temperature
-13° F + 158° F -25° C to 70° C

Material

Noryl NH 5110E

Color

Light GREY RAL 7035

Standard Length

6 Feet 6 3/4 Inches

Standard Unit

Duct complete with cover

Service temperature**

-13° F to 194° F
-25° C to 90° C

Flammability

UL 94 V-1

Oxygen Index

34.0% (ISO 4589-2)



T1EH

HALOGEN FREE WIRING DUCT: NARROW FINGER

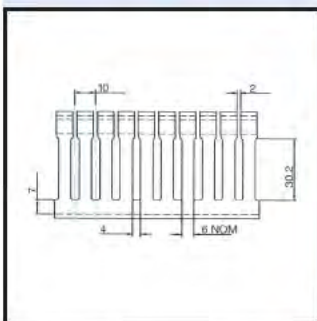

Measurements

Catalog Number	Size (w x h)	Size (Millimeters)	Standard Carton (Feet)
T1EH-1515LG	1½ x 1½	37.5 x 37.5	72
T1EH-1520LG	1½ x 2	37.5 x 50	72
T1EH-1530LG	1½ x 3	37.5 x 75	72
T1EH-2020LG	2 x 2	37.5 x 50	72
T1EH-2030LG	2 x 3	50 x 75	72
T1EH-3020LG	3 x 2	75 x 50	72
T1EH-3030LG	3 x 3	75 x 75	48
T1EH-4020LG	4 x 2	100 x 50	48
T1EH-4030LG	4 x 3	100 x 75	48

LG = LIGHT GREY RAL 7035

**Except T1EH-4030LG Service temperature
-13° F + 158° F -25° C to 70° C

Material

Noryl NH 5110E

Color

Light GREY RAL 7035

Standard Length

6 Feet 6 3/4 Inches

Standard Unit

Duct complete with cover

Service temperature**

-13° F to 194° F
-25° C to 90° C

Flammability

UL 94 V-1

Oxygen Index

34.0% (ISO 4589-2)

For wire fill capacity and base perforation of the wiring duct, see page 18.

CL

WIRE RETAINERS

Material

ABS/PC

Color

Dark GREY
RAL 7021

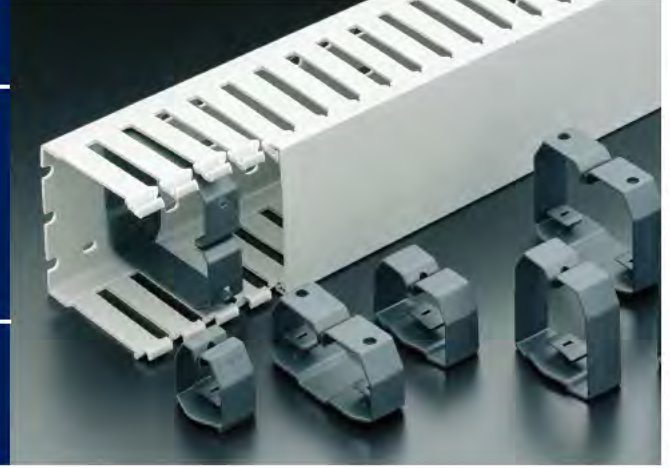

CL Wire Management Retainers

- Retains wires during installation
- Provides additional strain relief of fingers
- Eliminates bulging against sidewall

Catalog Number	Number Size (WxH)	Pieces per Carton
CL-1515	1½x1½	40
CL-1522	1½x2¼	40
CL-1530	1½x3	20
CL-2215	2¼x1½	40
CL-2222	2¼x2¼	20
CL-2230	2¼x3	20
CL-2240	2¼x4	20
CL-3022	3x2¼	10
CL-3030	3x3	10
CL-3040	3x4	10
CL-4015*	4x1½	10
CL-4022	4x2¼	10
CL-4030	4x3	10
CL-4040	4x4	5
CL-6040	6x4	5



W = 1½ - 2¼

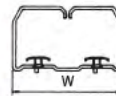

W = 3" - 4"

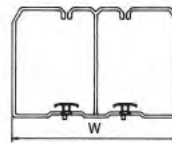

W = 6"

Catalog number indicates to which duct size (W x H) the CL will fit.

CL wire retainers come complete with mounting elements.

NEW DESIGN avoids fall out of wires especially in ceiling installations.

* Limited quantities available

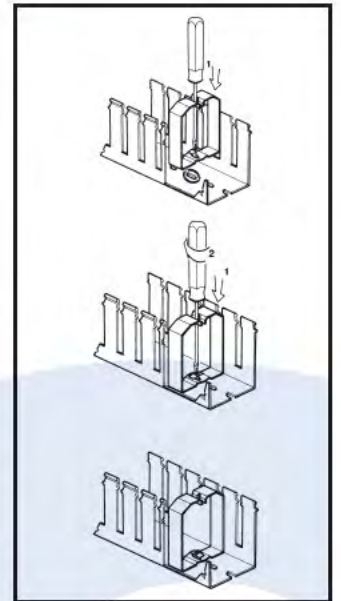

TR1/TR1-E

WIRE RETAINERS PREDETERMINED BREAKLINES

Material

ABS/PC

Color

BLACK



Catalog Number	Pieces per Carton
TR1*	50
TR1E**	50

* For T1

** For T1-E

A simple to use wire retainer that mounts on the duct fingers. Has predetermined scorelines so that "one size fits all". The TR1 and the TR1-E can be used on the 6", 4", 3", 2¼" and 1½" T1 and T1-E duct. The quick solution for every panel builder during initial panel wiring and maintenance operation.





SEP-E

SEPARATORS

Material

Rigid PVC,
self-extinguishing

Color

Light GREY RAL 7030

Standard Length

6 Feet 6 3/4 Inches

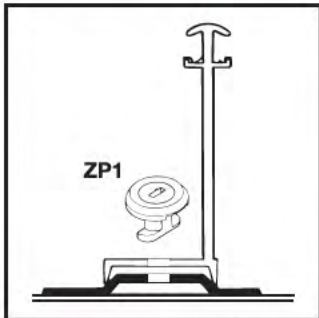

ZP1

SEP-E Mounting detail

Catalog Number	Use With Duct Nominal Height	Standard Carton	
		Feet (Meters)	Lengths
SEP-15E	1½	192 (64)	32
SEP-22E	2¼	120 (40)	20
SEP-30E	3	72 (24)	12

SEP-E allows the physical separation of circuits with different voltages and/or functions.



DUCTMARK

IDENTIFICATION TAG

Material Support and Insert

Polyamide 6

Color

BLACK

Slide

Transparent Polystyrene

Label

White cardboard



Ductmark is mounted by snapping it onto the sidewall finger segments taking care that it is placed above the wires coming out to the sidewall slots.



DM 1

Catalog Number	Pieces per Carton
DM 1	50

Cannot be used on T1-E Duct.

Resolves in a practical and functional manner the problem of circuit identification.

DUCTMARK

- need not be removed during maintenance or alteration work which involves the removal of the covers
- is always clearly visible

DUCTFIX

WIRING DUCT RIVETS

Material

Polyamide 6

Color

R4 - BLUE

R6N - NATURAL

R6O - ORANGE



Catalog Number	Pieces per Carton
R4	250
R6N	250
R6O	250

DUCTFIX

- Installs quick and easy using the B4 or B6 rivet tool.
- Can be used to install all types of wiring duct with standard mounting holes.
- Hole size R4 - 5/32" (4 mm) – R6 - 7/32" (5.5 mm)

MAIN FEATURES

- Elastic Vibration - dampening head
- Good temperature resistance
- Excellent mechanic properties
- Extremely short installation time
- Insulating - Functional - Easy To Apply
- R4 - use B4 or RT4 tool
- R6N - use B6 tool
- R6O - use RT6 tool

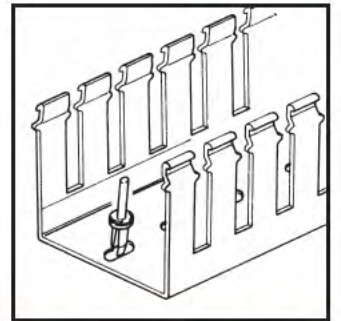

B4-B6 RT4 - RT6

Catalog Number	Pieces per Carton
B4*	1
B6*	1
RT4**	1
RT6**	1

* All plastic

** All metallic - note different rivets for RT6

Functional and sturdy



RIVET TOOLS

Color

B4 - RED

B6 - YELLOW

RT4 - BLUE

RT6 - ORANGE

ZP1-ZP2

MOUNTING INSERTS CABLE ATTACHMENTS

Material

Polyamide 6

Color

WHITE

Catalog Number	Pieces per Carton
ZP1	100
ZP2	50

With a simple quarter turn ZP2 can be mounted inside duct. By stacking, mounting levels at different heights are achieved. For tightening a wire bundle inside duct, pass a cable tie through ZP2.

With a simple quarter turn, ZP1 is used to mount components and SEP-E separators inside duct. Also ZP1 can be used to mount smaller sizes of duct inside larger sizes, thus achieving separation of circuits with different voltages and/or functions.

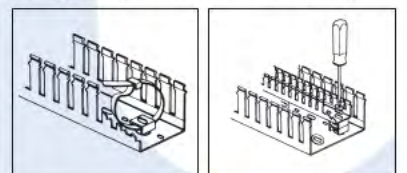



Available after July **NEW DESIGN**



DINOSAUR

**FLEXIBLE
DUCTS
SELF-ADHESIVE**

Dinosaur Duct is a unique product offering from IBOCO that is a flexible, resilient and efficient harnessing solution to your wiring needs.

For wiring to cabinet doors, from control panels and for electronic equipment.

For that part of the cable run that leans against the side of the control cabinet.

- Due to the flexibility of the material individual wires can easily be added, or removed from total wires within the duct.
- Since Dinosaur has no cover it can accommodate cables in restricted space applications, and also effectively removes the need for cable ties.
- It can be used in extreme operating conditions (i.e. max. temp. up to 176°F) and has excellent resistance to radiation if exposed to a nuclear environment.
- Dinosaur withstands mechanical stress when installed (i.e. earthquake, falling equipment) while in the event of fire does not emit corrosive, nor toxic gases, and smoke development is minimal.
- The duct can be cut to desired length using scissors or knife.

When applying the Dinosaur with adhesive tape, it is necessary to make sure that the surface is perfectly clean and dry.

Catalog Number	Nominal Size	Lengths* per Carton
DN 25AG	.50 x .75	24
DN 35AG	1.00 x 1.38	24
DN 45AG	1.38 x 1.75	14

* Each length is 19.7 inches (500 mm)

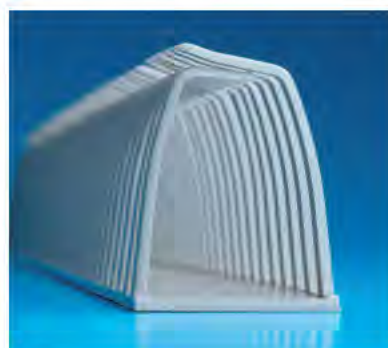

Material

Polypropylene
self-extinguishing

Color

GREY
RAL 7030

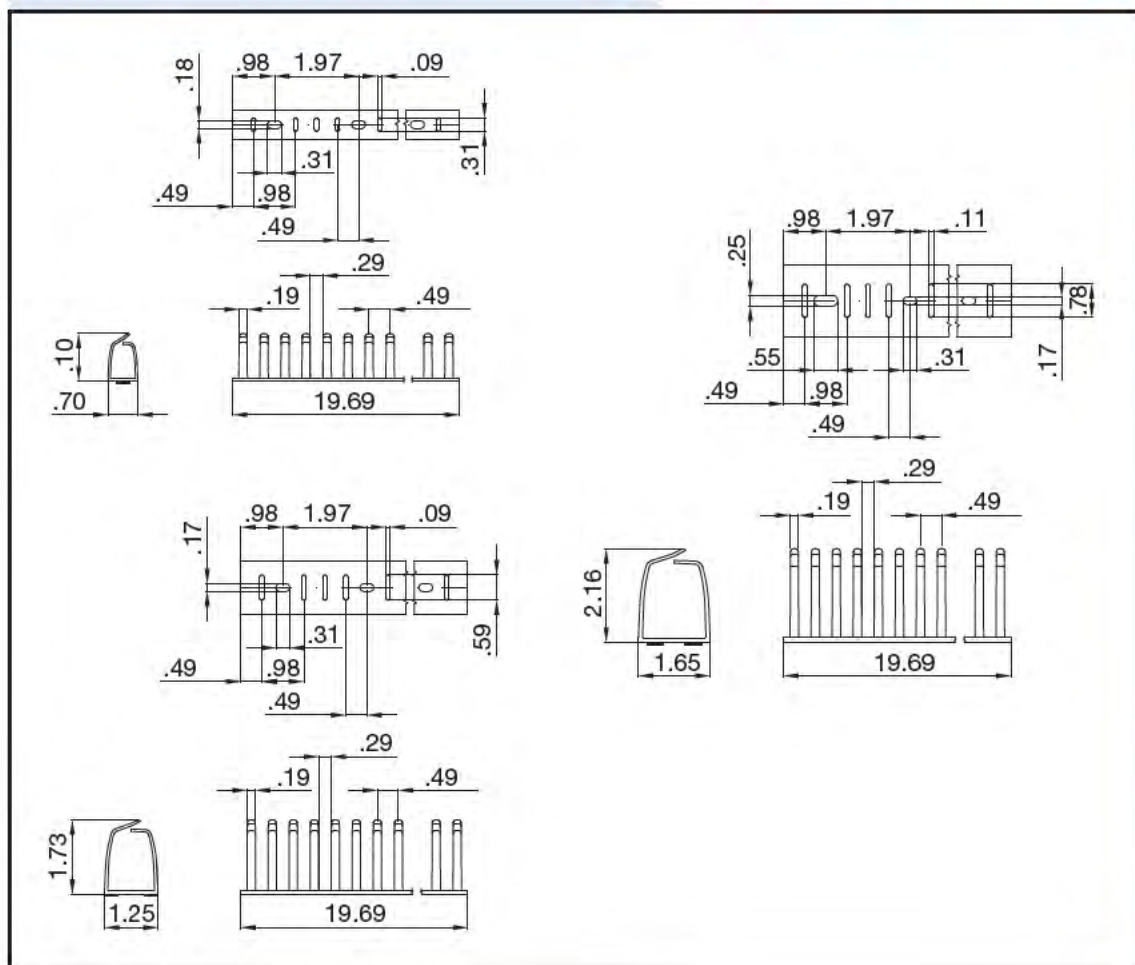

SPIRALITE



UNIVERSAL SPIRAL WRAPS

Material

Polyethylene
Natural (P)
Polyethylene
self-extinguishing (PA)
Polyethylene Black (PK)

According
to ASTM D 635

Catalog Number	Dimensions Inches			For Wire Bundles	Feet per Carton
	A	B	C		
P1 - PA1 - P1K	.06	.12	.20	1/16 to 1/2"	160
P2 - PA2 - P2K	.16	.24	.31	1/4" to 2"	80
P3 - PA3 - P3K	.31	.39	.47	3/8" to 3"	80
P4 - PA4 - P4K	.35	.47	.47	1/2" to 4"	65

Color black - 100 feet rolls only

Essential

- for fast and economical grouping of wire bundles.
- for joining groups of wires and/or tubing for fluidic/pneumatic machine control.
- for flexible connections between panel and door.

Robust, yet simple to install, it gives mechanical protection to the wire bundle which remains flexible although rigidly held. Easily removed, it can be re-used in the case of temporary wiring.

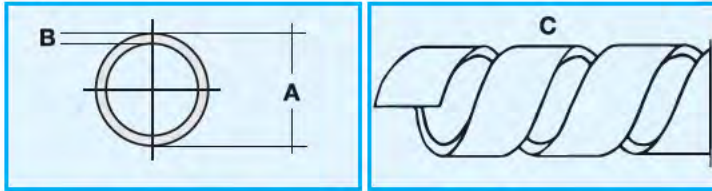

SLEEVING

BRAIDED EXPANDABLE SLEEVING

Material

Polyester

Color

BLACK - GREY

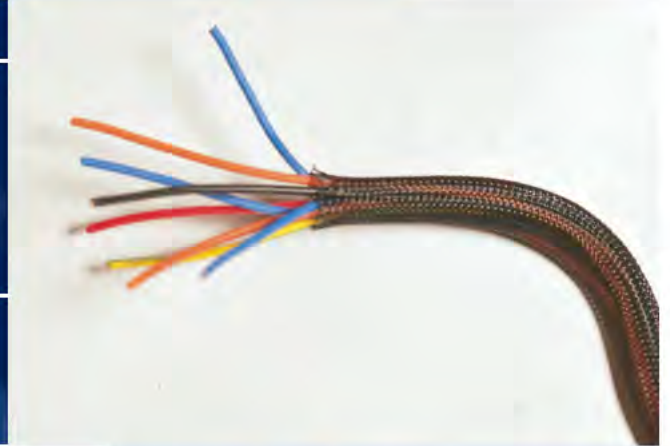

Catalog Number	Nominal I.D.		Nominal Diameter Range		QTY per Pack Feet
	Inches	(mm)	Inches	(mm)	
TY-5*	.197	(5)	.157 (4) to	.472 (12)	325
TY-10*	.375	(10)	.315 (8) to	.866 (22)	325
TY-20*	.750	(20)	.630 (16) to	1.378 (35)	164
TY-30*	1.125	(30)	.984 (25) to	1.890 (48)	164
TY-50*	2.000	(50)	1.575 (40) to	2.835 (72)	164

Polyester - Halogen Free - Rated -58°F to +302°F (-50°C to +150°C)
* Color - add suffix "G" for GREY and "B" for BLACK

Product Characteristics

Operating temperature:	- 50°C to + 150°C
Physical properties:	Self-extinguishing for UL 94V2
Maximum elongation:	42%
Diameter expansion:	100%
Other:	Halogen - free

DIN RAILS

RoHS compliant

Treated with galvanic zinc plating and passivation (gal Zn 8c according to Din 50960)
Minimum thickness 6 microns
Standard length: 2 meters (6'6¾")

The most comprehensive range of *Din metal mounting rails*

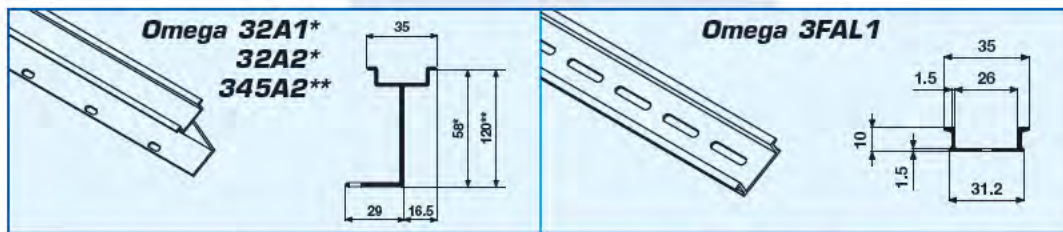
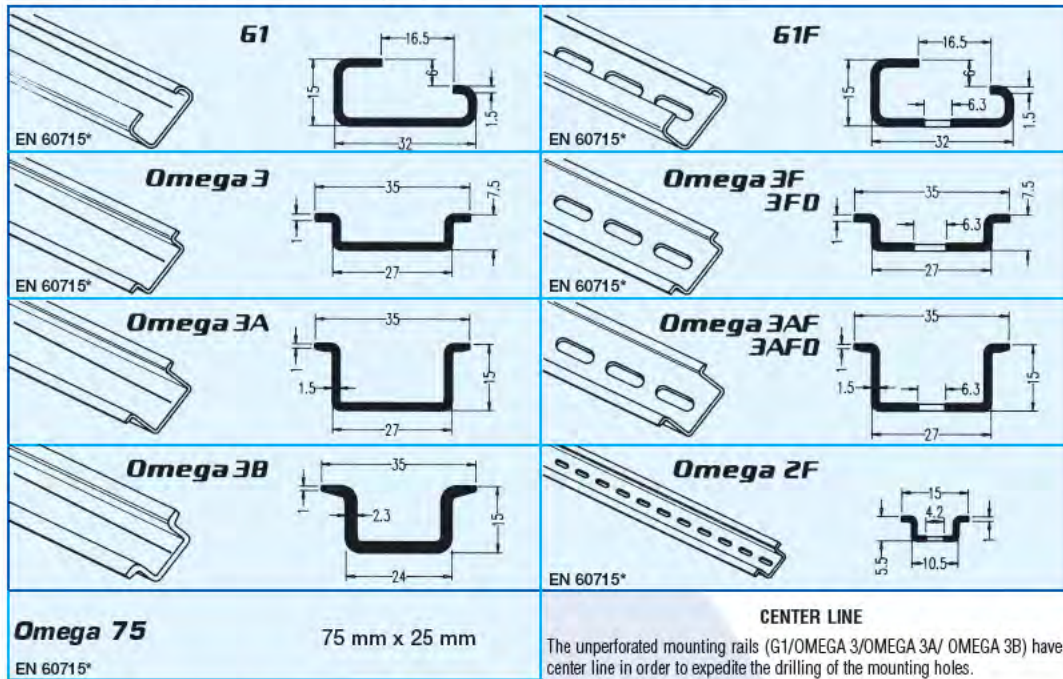

Catalog Number	Lengths per Pack	Catalog Number	Lengths per Pack
G1	12	ALUMINUM	
G1F	12	OMEGA 32A1	6*
G1F1	24	OMEGA 32A2	6
OMEGA 2F	20	OMEGA 3FAL1	40*
OMEGA 2F1	40*	OMEGA 345A2	2
OMEGA 3	20	GROMMET	
OMEGA 3F	20	IG-11	10
OMEGA 3F1	40*	COPPER	
OMEGA 3FD	20	OMEGA 3ACU	1
OMEGA 3A	10	STAINLESS STEEL	
OMEGA 3AF	10	OMEGA 3SS	4
OMEGA 3AF1	20*	OMEGA 3SS1	8*
OMEGA 3AFD	10		
OMEGA 3B	10		
OMEGA 3B1	10*		
OMEGA 75	2		

*One meter long

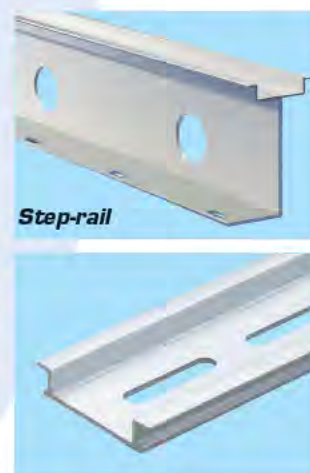

Bottom mtg. holes

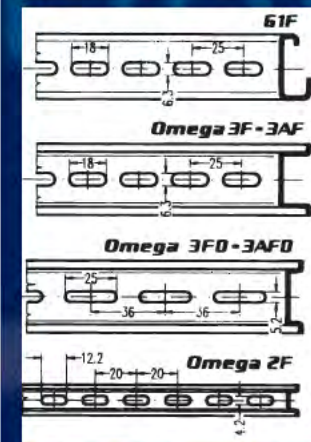

Omega 32A1 32A2

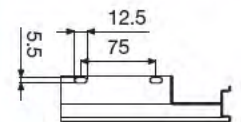

Omega 3FAL1

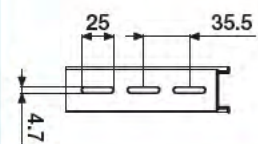

DINCLIC

MOUNTING CLIPS

Material

Zinc plated steel



With its help, one can snap onto all the mounting rails (except OMEGA 2F) those small switching devices which are not made for mounting on DIN rails.

Catalog Number	Pieces per Pack
DINCLIC DM4	40
DINCLIC FM4	40
DINCLIC FM5	40

Dinclic DM4 For mounting on rail G1, G1F
 Dinclic FM4 - FM5 For mounting on OMEGA 3 - OMEGA 3A - OMEGA 3F
 OMEGA 3AF - OMEGA 3B - OMEGA 3FD

Screw size
 FM4 and DM4 - 4 mm
 FM5 - 5 mm (US 10-32 can be used)

ST-ST5

DIN RAIL SUPPORT BRACKETS

Cold-rolled steel treated with galvanic zinc plating and passivation

Catalog Number	Pieces per Pack
ST	10
STS 25	10
STS 50	10
STS 70	10
STS 90	10

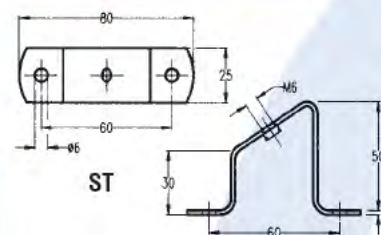

6 mm screws included ST and STS screw size 6 mm All dimensions shown are in mm

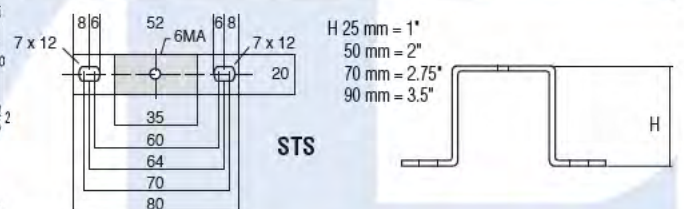

DINFIX

MOUNTING CLIPS

Material

Acetal resin (delrin) and galvanized steel

Catalog Number	Pieces per Pack
DINFIX 64	50
DINFIX 53	50

Dinfix permits the smooth mounting of metal rails on the mounting rail G1, thus allowing the construction of supporting frames for switchgear and wiring duct. DINFIX furthermore offers the possibility of installing onto the parallel rail G1, switchgear of a certain size and weight (e.g. transformers or contactors) that are not predisposed for snap-on assembly on Omega 3/3A/3B. Service Temperature Limit (4°F to 212°F)



Once they are mounted, the Dinfix form a strong mounting plane at the level of the upper flange of the rail G1.

Panel Management

With IBOCO's Space Saver Panel Management System



In a dual entry or swing out panel application, this new and innovative panel management system provides a faster, effective and efficient installation.

Save Space

Use up to 30% less panel space

Save Labor

Installations are clean and simple with ZP-1 mounting inserts

Save Money

Use smaller enclosures for your next project

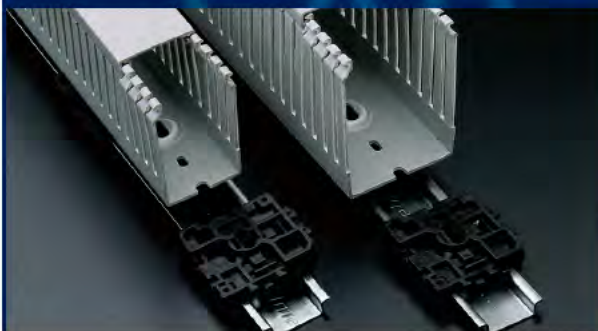

DINBLOK

MOUNTING BLOCKS

Material

Acetal Resin

Color

BLACK

DinbloK 3

for mounting rails
Omega 3 type
Color: BLACK

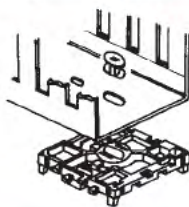

Catalog Number

DINBLOK 3

Pieces per pack.

25

DINBLOKS come complete with ZP1

Wire Fill Capacity T1/T1-E/T1H/T1EH

T1/T1-E

Nominal Duct Size	INSULATION THICKNESS					
	12 AWG	14 AWG		16 AWG	18 AWG	22 AWG
	1/32 OD-.158	3/64 OD-.165	1/32 OD-.139	1/32 OD-.125	1/32 OD-.113	1/64 OD-.065
1/2 x 5/8	7	6	9	11	14	43
1/2 x 1	12	11	16	20	24	74
1/2 x 2 1/4	25	23	33	40	50	150
1 x 1	22	21	29	36	44	134
1 x 1 1/2	31	28	39	48	59	180
1 x 2 1/4	45	40	57	71	85	261
1 x 3	59	53	75	92	113	341
1 x 4	72	66	93	115	141	426
1 1/2 x 1 1/2	51	46	65	81	99	299
1 1/2 x 2 1/4	77	70	98	121	148	449
1 1/2 x 3	102	92	130	160	196	593
1 1/2 x 4	125	113	159	197	241	729
2 1/4 x 1 1/2	78	70	99	123	150	453
2 1/4 x 2 1/4	114	103	146	180	221	667
2 1/4 x 3	156	141	199	246	302	912
2 1/4 x 4	194	176	247	306	375	1132
3 x 1 1/2	105	95	134	165	203	612
3 x 2 1/4	159	144	203	251	307	928
3 x 3	214	193	272	337	412	1246
3 x 4	267	242	341	421	515	1558
3 x 5	309	283	399	493	604	1826
4 x 1 1/2	132	120	169	208	255	771
4 x 2 1/4	201	182	256	316	387	1171
4 x 3	270	244	344	425	520	1573
4 x 4	336	305	429	531	650	1963
4 x 5	415	381	536	663	812	2455
6 x 4	512	464	653	807	988	2987

Recommended Maximum Number of Wires To Be Used per Wiring Duct (MTW)
BASED ON 60% FILL CAPACITY

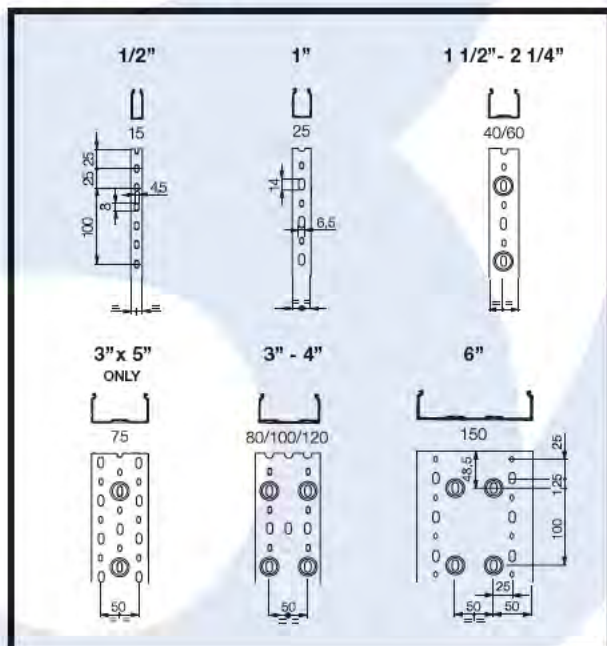

T1H/T1EH

Nominal Duct Size	INSULATION THICKNESS					
	12 AWG	14 AWG		16 AWG	18 AWG	22 AWG
	1/32 OD-.158	3/64 OD-.165	1/32 OD-.139	1/32 OD-.125	1/32 OD-.113	1/64 OD-.065
1 x 1 1/2	34	32	45	56	68	206
1 x 2	46	43	60	74	91	275
1 x 3	69	64	90	111	136	412
1 1/2 x 1 1/2	52	48	68	84	102	310
1 1/2 x 2	69	64	90	111	136	412
1 1/2 x 3	104	96	135	167	205	619
2 x 2	93	85	120	149	182	550
2 x 3	139	128	180	223	273	826
2 x 4	186	171	241	298	364	1101
3 x 2	139	128	180	223	273	826
3 x 3	209	192	271	335	409	1238
3 x 4	279	256	361	446	546	1651
4 x 2	186	171	241	298	364	1101
4 x 3	279	256	361	446	546	1651
4 x 4	372	342	481	595	728	2202

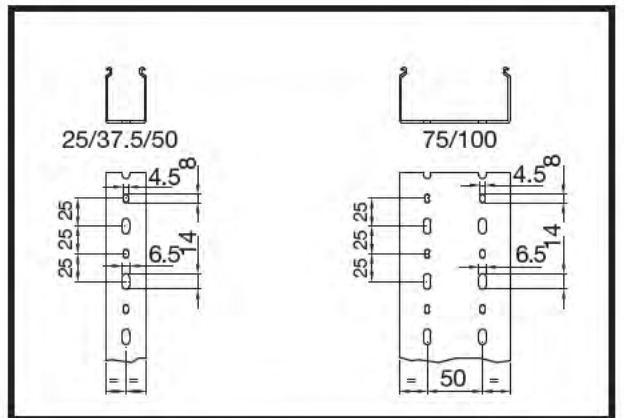

Duct-System Base Perforation According to DIN 43659 and to DIN VDE 0660 TEIL 506

The base perforation of the wiring duct series T1, T1E, T1H and T1EH allows mounting on the panel with DUCTFIX R6 or R4.

The recess bosses in the base of duct series T1, T1E permit rapid mounting of components CL, ZP2 and SEP-E inside the wiring duct.

All dimensions shown are in millimeters. For conversion to inches see below.
(25.4 millimeters = 1 inch)

millimeters	= Inches	millimeters	= Inches
4.5	.177	50	1.969
6.5	.256	60	2.363
8	.315	80	3.150
14	.551	100	3.937
15	.591		
25	.984		
40	1.575		

TOOLS

SX-15 Wiring Duct Cutter



WT-2 Duct and tubing cutter



Features and Benefits

- Heavy-duty stainless steel blade
- Easy-grip handle
- Smooth, burr-free cuts on duct and cover
- Quick, easy cutting
- For use with all IBOCO wiring duct products, including DINOSAUR DUCT

Catalog Number		Pieces per Pack
SX-15	Hand duct cutter	1
SX-15B	Blade	1

Catalog Number		Pieces per Pack
WT-2	Duct and tubing cutter	1
WT-2B	Blade	1

DC-510 Din Rail cutter



Features and Benefits

- Cuts Omega 3/2F/3F/3A/3AF/G1/G1F 6 mm (~ 1.4") steel rods, threaded or not
- Punches oblong hole 8.8 mm x 5 mm (0.35" x 0.20") in either direction on the axis of the rail
- Includes 1m ruler (imperial/metric) with End Stop

Catalog Number		Pieces per Pack
DC-510	Rail cutter	1

Cutter

Catalog Number		Pieces per Pack
BL-120	Wiring duct cutter	1
DCA-100	Aluminium rail cutter	1

Cable Tie Installation Tools

ITT-1

ITT-2A



Catalog Number	Pieces per Pack
ITT-1	1
ITT-2A	1

ICT

CABLE TIES

Material

6/6 Nylon

Color

NATURAL - BLACK

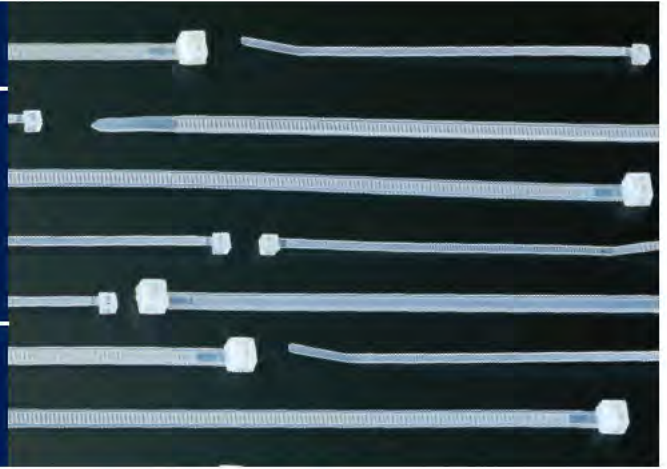

Catalog Number	Quantities Available	Length		Min. Loop Tensile Strength	Maximum Bundle Dia.		
		in.	(mm)		in.	(mm)	
ICT-18R*	C-M	3.96	(100)	18 LBS.	.875	(22)	
ICT-18RB*	C-M	"	"		"	"	
ICT-18L	C-M	6.15	(156)		"	1.63	(41)
ICT-18LB	C-M	"	"		"	"	"
ICT-18V	C-M	8.00	(203)		"	2	(50)
ICT-18VB	C-M	"	"	"	"	"	
ICT-40R*	C-M	5.78	(146)	40 LBS.	1.38	(35)	
ICT-40RB*	C-M	"	"		"	"	"
ICT-40L	C-M	8.78	(223)		"	2.13	(54)
ICT-40LB	C-M	"	"		"	"	"
ICT-50R*	C-M	7.49	(190)	50 LBS.	1.75	(44)	
ICT-50RB*	C-M	"	"		"	"	"
ICT-50T*	C-D	11.3	(287)		"	3	(76)
ICT-50TB*	C-D	"	"		"	"	"
ICT-50L*	C-D	14.5	(368)		"	4	(102)
ICT-50LB*	C-D	"	"		"	"	"
ICT-120R*	C	15	(381)	120 LBS.	4	(103)	
ICT-120RB*	C	"	"		"	"	"
ICT-120T	C	18	(457)		"	5.25	(133)
ICT-120TB	C	"	"		"	"	"
ICT-120V	L	24	(610)		"	7	(178)
ICT-120VB	L	"	"		"	"	"
ICT-120X*	L	28	(711)		"	8	(203)
ICT-120XB*	L	"	"		"	"	"

Suffix B indicates BLACK
For other colors/sizes contact sales office

*MIL-SPEC Ties - Natural only

EXTRA HEAVY DUTY

Catalog Number	Quantities Available	Length		Min. Loop Tensile Strength	Maximum Bundle Dia.		
		in.	(mm)		in.	(mm)	
ICT-175V*	L	24	(610)	175 LBS.	7.2	(183)	
ICT-175VB*	L	"	"		"	"	"
ICT-175R*	L	37	(940)		"	11	(279)
ICT-175RB*	L	"	"		"	"	"
ICT-175T*	L	48	(1219)		"	14.5	(368)
ICT-175TB*	L	"	"		"	"	"
ICT-250R*	C	22.8	(579)	250 LBS.	6	(152)	
ICT-250RB*	C	"	"		"	"	"

Suffix B indicates BLACK
For other colors/sizes contact sales office

*MIL-SPEC Ties - Natural only

RELEASABLE

Catalog Number	Quantities Available	Length		Min. Loop Tensile Strength	Maximum Bundle Dia.		
		in.	(mm)		in.	(mm)	
ICT-50RLR	C	5.9	(149)	50 LBS.	1.25	(32)	
ICT-50RLRB	C	"	"		"	"	"
ICT-50RLS	C	7.8	(198)		"	2	(51)
ICT-50RLSB	C	"	"		"	"	"
ICT-50RLL	C	11.75	(298)		"	3	(76)
ICT-50RLLB	C	"	"		"	"	"

Suffix B indicates BLACK

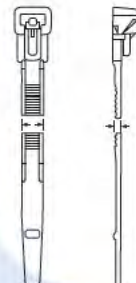

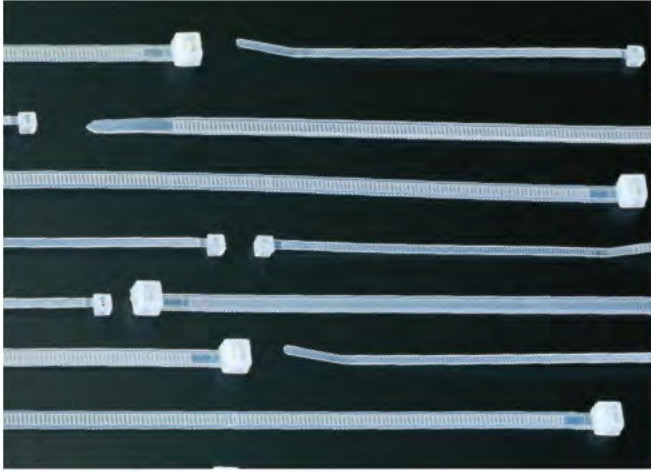

ICT

CABLE TIES

Material

6/6 Nylon

Color

NATURAL - BLACK

MOUNTING HOLES

Catalog Number	Quantities Available	Length in.	Length (mm)	Min. Loop Tensile Strength	Maximum Bundle Dia. in. (mm)	Screw Hole		
ICT-30MHR ICT-30MHRB	C C	6"	(152)	30 LBS.	1.25" (32)	NO.8		
ICT-50MHS ICT-50MHSB	C-M C-M	8"	(205)	50 LBS.	1.75" (44)	NO.10		
ICT-50MHT ICT-50MHTB	C C	11.7"	(298)					
ICT-50MHL ICT-50MHLB	C C	14"	(368)					
ICT-120MHL ICT-120MHLB	C C	15"	(396)		120 LBS.		4" (102)	NO.10

Suffix B indicates BLACK

Stainless Steel cable ties available, contact sales

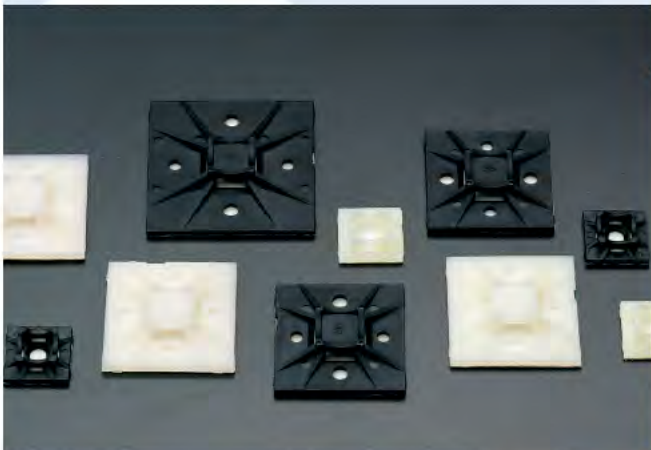
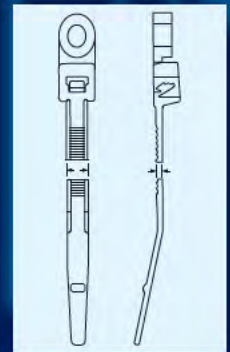

ICM

CABLE MOUNTS

Material

6/6 Nylon

Color

NATURAL - BLACK

Catalog Number	Pieces per Pack
ICM-75	100
ICM-75B	100
ICM-100	100
ICM-100B	100

Color Standard Natural
Suffix B indicates BLACK

ICM-75 and 100



LIQUIDTIGHT CONDUIT

GSI - NON METALLIC



Material

Soft PVC
with rigid PVC
external spiral

Color

LIGHT GREY
BLACK

Catalog Number	Nominal ID	Actual ID	Coil length
GSI-12*	3/8	0.47	98' (30mtrs)
GSI-16*	1/2	0.63	98' (30mtrs)
GSI-20*	3/4	0.79	98' (30mtrs)
GSI-25*	1	0.98	98' (30mtrs)
GSI-32*	1-1/4	1.25	98' (30mtrs)
GSI-40*	1-1/2	1.57	98' (30mtrs)
GSI-50*	2	1.97	98' (30mtrs)

* Color - add suffix "G" for LIGHT GREY and "K" for BLACK



RPS - STRAIGHT LIQUIDTIGHT FITTING



Material

Fire resistant
Polypropylene

Color

LIGHT GREY
BLACK

Catalog Number	Nominal ID	Actual ID	Pieces per pack
RPS-12*	3/8	0.47	20
RPS-16*	1/2	0.63	20
RPS-20*	3/4	0.79	20
RPS-25*	1	0.98	10
RPS-32*	1-1/4	1.25	10
RPS-40*	1-1/2	1.57	5
RPS-50*	2	1.97	5

* Color - add suffix "G" for LIGHT GREY and "K" for BLACK



CUR - 90° LIQUIDTIGHT FITTING



Material

Fire resistant
Polypropylene

Color

LIGHT GREY
BLACK

Catalog Number	Nominal ID	Actual ID	Pieces per pack
CUR-12*	3/8	0.47	25
CUR-16*	1/2	0.63	25
CUR-20*	3/4	0.79	15
CUR-25*	1	0.98	5
CUR-32*	1-1/4	1.25	5

* Color - add suffix "G" for LIGHT GREY and "K" for BLACK
- For 1 1/2" and 2" contact sales office



GT - GASKETS

Catalog Number	Fits RA/CUR	Pieces per pack
GT-12	12	25
GT-16	16	25
GT-20	20	25
GT-25	25	20
GT-32	32	20
GT-40	40	10
GT-50	50	10



Adhesive Backed Duct

Adhesive tape can be applied to all sizes of our T1, T1E, TS and TSH Wiring Duct Series products.

Adhesive backing can be used for the following applications:

1) TEMPORARY MOUNTING (See Table Below):

Gives installer ample time to secure duct (rivets or screws) with precision and accuracy.

2) PERMANENT MOUNTING:

Significantly reduces labor costs and time by eliminating the need to drill or tap holes during installation. IBOCO recommends the entire width of the duct be covered with an Acrylic based adhesive tape. Contact factory for pricing;

Note: IBOCO recommends that, when using acrylic tape, approximately 12 hours of curing time is allowed.

**Factory Applied Tape
(Temporary Mounting)
Rubber Based Only**

Duct Size W x H	Rows of Tape	Tape Size (in)	Tape Thickness
.5 x .5 Thru 1.5 x 2.25	1	.50	.0313
1.5 x 3 Thru 3 x 2	2	.50	.0313
3 x 3 Thru 3 x 5	2	.75	.0313
4 x 1.5 Thru 4 x 5	2	.75	.0313
6 x 4	3	.75	.0313

Please add an "A" to the part number when ordering (i.e. T1-2230GA).

Adhesive is applied as ordered.

For pricing please contact the factory.

Rolls of Adhesive to Purchase Separately

Part Number	Tape Size (in)	Roll Length (ft)
Acrylic		
MT-32A88	.875	216
MT-32A150	1.5	216
MT-32A212	2.125	216
Rubber		
MT-32A50	.50	216
MT-32A75	.75	216

Tape Specifications:

- * Double-sided rubber based polyolefin foam tape
- * Application Temperature Range 65° F to 100° F
- * General Service Temperature -20° F to 175° F

Technical Characteristics of Materials

IBOCO wiring products respond to all installation needs, coping with different uses and environment applications. They are manufactured with high quality materials that undergo severe quality controls and performance tests under extreme operating and duration conditions with a constant control of quality standards.

- WIRING DUCTS T1, T1-E, T1-K, T1-B, TS, TSH, SEP-E, CL, COV, TR1 and TR1-E are manufactured in rigid SELF-EXTINGUISHING PVC.
- Halogen Free wiring ducts T1H, T1EH are manufactured in Noryl NH 5110 E
- Those components for which high bending resilience is required are in polyamide 6 and polypropylene.
- SPIRALITE is manufactured in natural polyethylene and self-extinguishing polyethylene.

MATERIALS			PVC DUCT	NORYL	ABS/PC	POLYAMIDE 6	POLYETHYLENE	FLAME RETARDANT POLYETHYLENE	POLYPROPYLENE SELF EXTINGUISHING WHITE	POLYPROPYLENE SELF EXTINGUISHING GREY RAL 7030
TECHNICAL CHARACTERISTICS										
CHEMICAL-PHYSICAL PROPERTIES	UNIT OF MEASURE	STANDARD	Value	Value	Value	Value	Value	Value	Value	Value
Specific gravity	g/cm ³	ASTM D792	1.55	1.09	1.20	1.14	0.92	0.97	1,01	0,95
H ₂ O 73,4° F absorption	%	ISO 62	<0,1	0,15	0,4	2,5	<0,1	<0,1	<0,1	<0,1
Formaldehyde	ppm	–	absent	absent	absent	absent	absent	absent	absent	absent
Cadmium	ppm	–	absent	absent	absent	absent	absent	absent	absent	absent
MECHANICAL PROPERTIES										
Tensile stress at break	MPa	ASTM D638	39	52	–	45	17	15	24	24
Traction strength	MPa	ASTM D638	44	64	–	55	9,5	9	28	28
Elongation at break	%	ASTM D638	130	18	–	250	400	600	200	200
Modulus of elasticity at traction	MPa	ASTM D638	4400	2500	–	950	–	240	–	–
Modulus of elasticity at flexion	MPa	ASTM D790	3200	2400	–	1100	210	130	1700	1500
THERMAL PROPERTIES										
Temperature VICAT	°C	ASTM D1525	84	138	112	198	89	–	95	95
HDT	°C	ASTM D648	72	114	98	185	–	–	90	90
Coefficient of expansion	K ⁻¹	ASTM D696	6 10 ⁻⁵	8-9 10 ⁻⁵	–	8-10 10 ⁻⁵	22 10 ⁻⁵	10 ⁻⁵	14 10 ⁻⁵	14 10 ⁻⁵
Specific heat	kJ/kgK	ASTM C351	0,94	–	–	1,7	–	–	–	–
Thermal conductivity	W/mK	ASTM C177	0,14	–	–	0,29	0,32	0,32	0,21	0,21
Operating Temperature	°C	–	50	90*	90	90	60	60	80	80
ELECTRICAL PROPERTIES										
Dielectric constant	–	ASTM D150	3,2 - 4,0	–	3,0	5,0	2,4	2,3	2,4	2,4
Dielectric strength	kV/mm	IEC 243	70	46	40	35	90	90	75	75
Surface resistance	Ohm	IEC 93	10 ¹³	–	10 ¹⁴	5 10 ¹¹	10 ¹³	10 ¹³	10 ¹³	10 ¹³
SELF-EXTINGUISHING										
Self-extinguishing 1,6 millimeters	–	UL 94	V0	V1	HB	V2	HB	V2	V0	V2
Self-extinguishing 3,2 millimeters	–	UL 94	V0	V1	HB	V2	HB	V2	V0	V2
Glow wire test (2 mm)	°C	IEC 60695-2-12	960	–	650	650	650	850	960	850
Oxygen number	%	ASTM D2863	43	34	–	25	–	25	30	25

*Except T1H-4030LG and T1EH-4030LG Operating temperature –25° C to 70° C

Rigid PVC Resistance to Chemical Agents

Chemical	Concentration	Temp. °C	Resistance	Chemical	Concentration	Temp. °C	Resistance
Acetic acid, hydrous	25%	40	+	Hexane		20	+
Acetic acid	100%	20	0	Hydrochloric acid	30%	40	+
Acetone	traces	20	-	Hydrogen	100%	60	+
Acetone	100%	20	-	Lead acetate, hydr.	saturated	50	+
Acqua regia		20	0	Lead tetra-ethyl	100%	20	+
Aluminium chloride, hydrous	thinned	40	+	Linseed oil	100%	60	0
Aluminium sulphate, hydr.	thinned	40	+	Lubricating oils	100%	20	+
Ammonia, concentrate	saturated	40	+	Methanol	100%	40	+
Ammonia, dry gas	100%	60	+	Milk	normal	20	+
Ammonia, liquid	100%	20	0	Mineral oil	100%	20	+
Aniline, pure	100%	20	-	Molasses		20	+
Antifreeze	commercial	20	+	Naphtalene		20	-
Arsenic acid, hydr.	thinned	40	+	Nitrous acid, liquid	30%	50	+
Barium hydroxide, hydr.		60	+	Oils and fats	commercial	60	+
Barium salts, hydr.		60	+	Oil of turpentine	100%	60	0
Beer	commercial	20	+	Ozone	100%	20	+
Bee's wax	commercial	20	+	Paraffin wax		60	+
Benzene	100%	20	+	Petroleum		20	0
Benzoic acid		20	+	Photographic developer	commercial	40	+
Bleaching lye	usual conc.	40	+	Photographic emulsions	commercial	40	+
Borax, hydrous	thinned	40	+	Potash lye, hydrous	40%	40	+
Boric acid, hydr.	thinned	40	+	Potassium permanganate	6%	20	+
Brandy	commercial	20	+	Propane, liquid	100%	20	+
Bromine, liquid	100%	20	-	Prussic acid		60	+
Butane, gaseous		20	+	Salicylic acid		60	+
Butadiene	50%	60	+	Sea water		60	0
Butanol	10%	20	+	Sebacic acid	100%	60	+
Butyric acid, hydr.	20%	20	+	Silicone oil	100%	20	+
Calcium chloride		60	0	Soda, hydrous	thinned	40	+
Camphor oil	100%	20	+	Sodium chloride	thinned	40	+
Carbon tetrachloride	100%	20	0	Spirits, all types	commercial	20	+
Carbon dioxide, dry	100%	60	+	Succinic acid, hydrous		60	+
Chlorine, gaseous, dry	100%	20	+	Sulphur		60	0
Chlorine, gaseous, moist	0.5%	20	+	Sulphuric acid, hydrous	40%	40	+
Chlorine, liquid		20	-	Tannic acid	10%	60	0
Chlorine water	saturated	20	0	Tetrahydrofuran	100%	20	-
Chromic acid, hydr.	50%	40	+	Toluene	100%	20	-
Citric acid, hydr.	10%	40	+	Tincture of Iodine	commercial	20	-
Copper sulphate, hydr.	thinned	40	+	Urea, hydrous	10%	40	+
Diesel oil	100%	20	+	Urine		40	+
Ethyl-alcohol	96%	20	+	Vaseline oil	100%	20	-
Formaldehyde, hydr.	thinned	40	+	Vinegar	commercial	40	+
Formic acid	100%	20	+	Water	100%	40	+
Freon 12	100%	20	+	Water steam		40	0
Gasoline	100%	60	+	Wines, red and white	commercial	20	+
Gelatin, hydr.		40	+	Zinc salts	saturated	60	0
Glycerine, hydr.		60	+	Zinc sulphate, hydrous	thinned	40	+
Heating oil		20	0				

+ Resistant, 0 Resistant in certain conditions, - Unsuitable

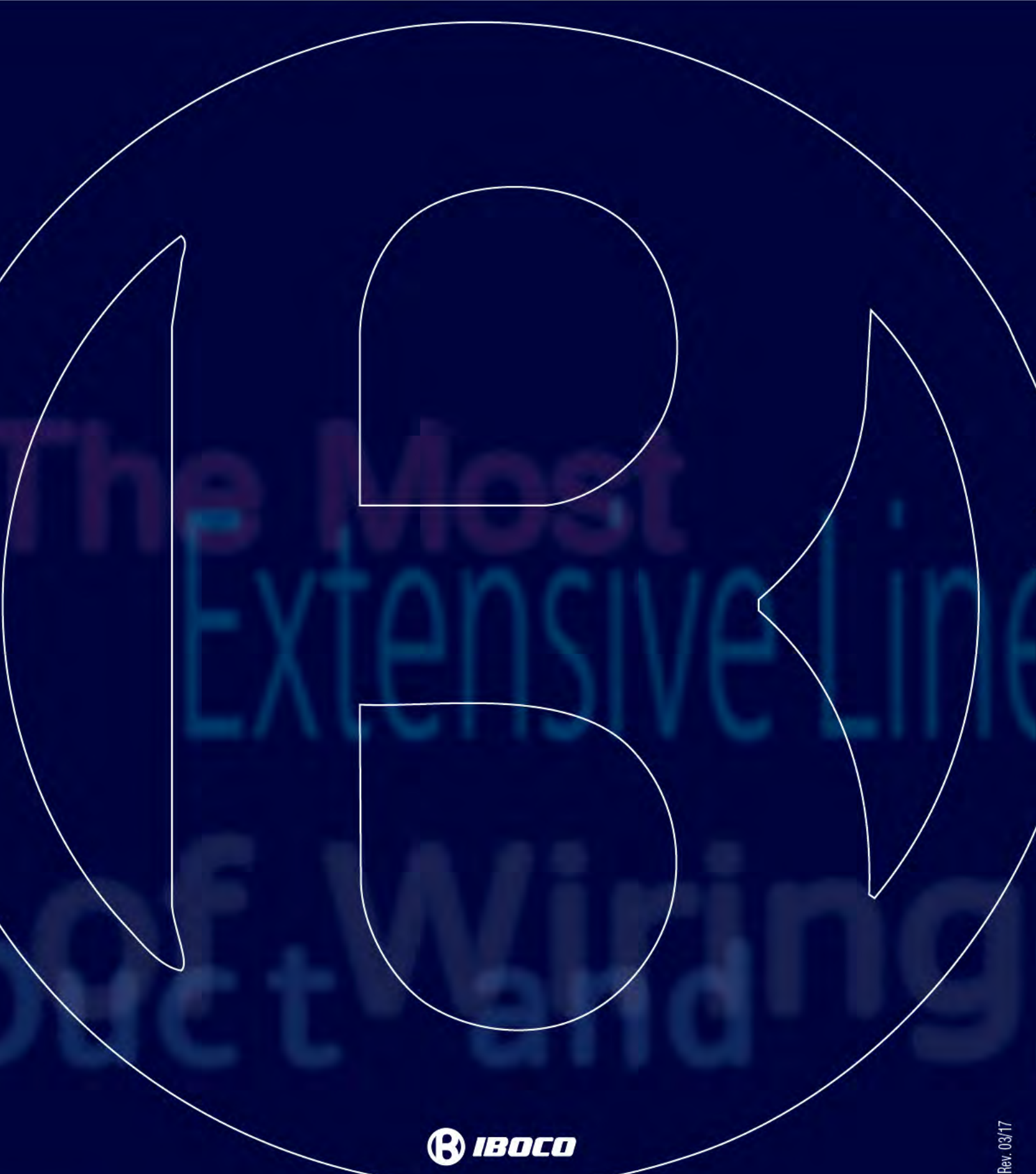

IBOCO Corporation
732-417-0066
www.iboco.com
A member of Hager Group