

Capacitive Sensor Section

CONTRINEX

HIGHLIGHTS:

- ✓ Detection of virtually all target materials
- ✓ Easy adjustment with potentiometer and LED
- ✓ Detection through non-metallic walls and containers
- ✓ Sensors for use in harsh chemical environments
- ✓ Reliable level control of sticky and viscous materials
- ✓ Sensors with hygienic, FDA-compliant, PTFE housings



A
Swiss
Company

INTRODUCTION

CONTRINEX USA

Contrinex is a leading manufacturer of sensors for factory automation. With a North American distribution center near Dallas Texas, this Swiss-founded company has a unique and innovative range of products whose features far surpass those of standard sensors.

Since its foundation in 1972 by Peter Heimlicher, Dipl Ing ETH, Contrinex has grown from a one-man operation to a multinational group with over 500 employees worldwide. More than 15 subsidiaries cover the core markets in Europe, Asia, North and South America.

At a glance

- Technology leading manufacturer of inductive and photoelectric sensors as well as safety and RFID systems
- World market leader for miniature sensors, sensors with long operating distances and devices for particularly demanding operating conditions (all-metal, high-pressure and high-temperature resistant sensors)
- Represented in over 60 countries worldwide, headquarters in Switzerland
- 8000 products
- Programmable IO-Link Sensors for the 4th Industrial Revolution utilize our intelligent ASIC.

CONTRINEX - SENSE MORE, DO MORE

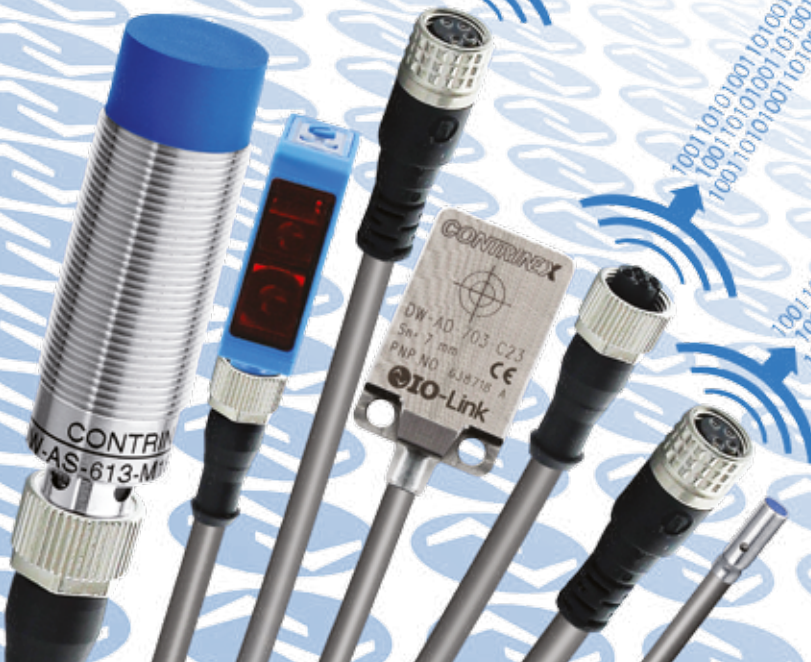

MARKET-LEADING INNOVATION

- 1979** Sensor business starts with self-contained subminiature inductive sensors: Ø4 mm (instead of M8 before)
- 1982** Launch of inductive sensor with patented Condist® technology – market leadership with operating distances 3x standard
- 1986** Launch of Ø3 mm inductive sensors, now market leader for subminiature inductive sensors
- 1996** Market launch of Ø4 mm subminiature photoelectric sensors
- 1999** Launch of world's first inductive sensor with full-metal housing – thanks to patented Condet® technology
- 2005** Integration of Contrinex's excellent performance for inductive sensors in CMOS-ASIC (Application-Specific Integrated Circuit), a proprietary development
- 2007** Launch of RFID products for closed loop industrial applications. First RFID product range with tags and readers in full-metal housing
- 2008** Launch of Safetinex®, the industrial safety product range
- 2009** The smart sensor is born. Launch of next generation ASIC, a “system on a chip”, including IO-Link interface
- 2011** Development starts on Contrinex's first ASIC for photoelectric sensors
- 2014** Launch of photoelectric sensor with new generation Contrinex ASIC and IO-Link



Early inductive sensor produced for own use in 1973 (special version for extreme conditions)



ASIC sensor technology



Safety product range



Subminiature photoelectric sensor



SENSORS

INDUCTIVE

BASIC
MINIATURE
EXTREME
EXTRA PRESSURE
HIGH PRESSURE
EXTRA TEMPERATURE
HIGH TEMPERATURE
WASHDOWN
ANALOG OUTPUT
2-WIRE
WELD-IMMUNE
SPECIAL

PHOTOELECTRIC

CYLINDRICAL SUBMINIATURE
CYLINDRICAL MINIATURE
CYLINDRICAL SMALL
CUBIC SUBMINIATURE
CUBIC MINIATURE
CUBIC SMALL
CUBIC COMPACT
FIBER-OPTICS

ULTRASONIC

MINIATURE
SMALL
COMPACT

CAPACITIVE

BASIC
HIGH PERFORMANCE

SAFETY

LIGHT CURTAINS



FINGER PROTECTION type 4
HAND PROTECTION type 4
SAFETY RELAYS
ACCESS CONTROL type 4
PROCESS CONTROL type 2

RFID

LOW AND HIGH FREQUENCY

TRANSPONDERS
CONTRINET
USB READ/WRITE MODULES
HANDHELD DEVICES
ACCESSORIES
SOFTWARE
STARTER KITS

PROGRAM OVERVIEW

PRODUCT RANGE		BASIC	HIGH PERFORMANCE
			
HOUSING SIZE	OPERATING DISTANCE		

CYLINDRICAL

M12	2 mm	p. 319	p. 327
	4 mm		p. 327
M18	5 mm	p. 320	p. 328
	8 mm	p. 320-321	p. 328
M30	10 mm	p. 321	p. 328
	15 mm	p. 322	p. 329
∅ 26 / G1	5 mm		p. 329

CUBIC

48.5 x 32 x 17 mm	15 mm	p. 323	
120 x 80 x 30 mm	40 mm	p. 323	

HOUSING SIZE	OPERATING DISTANCE											PAGE
	2 mm	4 mm	6 mm	8 mm	10 mm	12 mm	14 mm	16 mm	40 mm			
M12	2 mm											319, 327
		4 mm										327
M18			5 mm									320, 328
				8 mm								320-321, 328
M30					10 mm							321, 328
								15 mm				322, 329
∅ 26 / G1			5 mm									329
48.5 x 32 x 17 mm								15 mm				323
120 x 80 x 30 mm									40 mm			323

Inductive

Photoelectric

Ultrasonic

Capacitive

Safety

RFID

Connectivity

Accessories

Glossary

Index



INTRODUCTION

Capacitive sensors are used in machines, installations and vehicles for monitoring the levels of liquids, pastes and bulk material. These materials can even be detected through non-metallic dividing walls. In addition, capacitive sensors are suitable as limit switches, contact-free position switches, for monitoring and positioning, as pulse generators for counting purposes, distance and speed measurement, and much more.

OPERATING PRINCIPLE

The electrodes at the device's sensing face permit the sensor to detect the dielectric conditions in its close surroundings. Depending on the distance between the target (or material) to be detected and the capacitive sensor, the capacitance in the measuring zone changes. The capacitance is dependent not only on the above-mentioned distance, but also on the dielectric constant (ϵ_r) of the target, as well as its shape. As the sensor approaches the target, the capacitance increases. When the set threshold value is reached, the transistor-oscillator is activated. By means of the built-in electronics, a changeable, electrical current is generated which, depending on the execution of the device, is available as a linear current signal or as a binary voltage at the output.

Using capacitive sensors, electronic circuits and PLCs, as well as relays or contactors can be controlled directly.

Capacitive sensors are enclosed in synthetic or metal housings and potted in epoxy resin. They are, moreover, insensitive to dirt and shock.

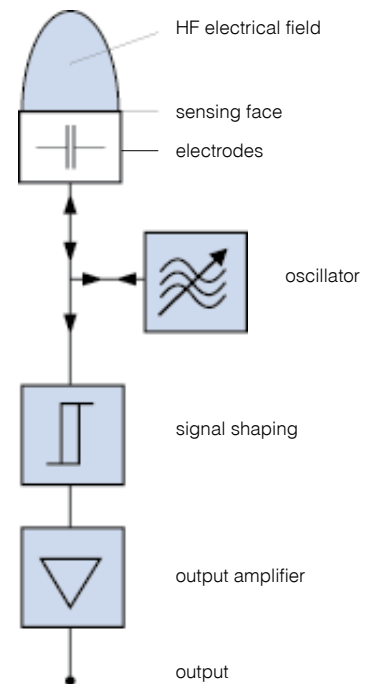

Fig. 15: operating principle

DELIVERY PROGRAM

Contrinex capacitive sensors deliver a reliable solution for all kinds of level sensing tasks. They are suitable for detection and position monitoring with virtually any target material. The program includes sensors in cylindrical (M12, M18 M30 or Ø 26/G1) or cubic form. Two ranges are offered: a cost effective **Basic** range, which includes AC/DC output switching, and a **High performance** range for difficult sensing tasks.

BASIC

Cost-effective with any target material – ideal for fill level sensing

The Contrinex **Basic** range consists of cylindrical and cubic devices. Cylindrical devices are available in 4-wire M12, M18 and M30 standard sizes. All 3 sizes may have PNP or NPN changeover outputs, while M30 devices are also available with 2-wire switching outputs (**AC/DC**, **NO**). Housings are either in durable polyphenylene oxide (PPO) or stainless steel



(V2A AISI 304) with a PPO sensing face. Sensor connection is by means of cable or an integral connector. All device types are available in embeddable versions, allowing detection through container walls. In addition, M18 and M30-sized devices are also available in non-embeddable versions that permit longer operating distances. Cubic devices are available, sized 32 x 34 mm in a PVC housing with 3-wire connection, or 120 x 80 mm in a PBT housing with 4-wire connection. With operating distances from 0.5 mm to 25 mm, Contrinex **Basic** range capacitive sensors are the cost effective solution for level sensing tasks in the plastics industry, in particular for the level control of granulates in feeders, pipes or silos.

HIGH PERFORMANCE

Challenging environments and viscous or sticky target materials

The Contrinex **High performance** range consists of 4-wire devices in M12, M18 and M30 standard sizes. All 3 sizes may have PNP or NPN changeover outputs. Hous-



ings are either in hygienic polytetrafluoroethylene (PTFE/Teflon) or stainless steel (V2A AISI 304) with a PTFE sensing face. Sensor connection is by means of cable or an integral connector. All these device sizes are available in non-embeddable or embeddable versions. Devices with a PTFE housing are FDA compliant and ideal for applications in food and pharmaceutical industries. This hygienic housing material cannot contaminate produced goods and resists chemical cleaning agents.

For the difficult task of sensing sticky and viscous materials, the **High performance** range includes Ø 26/G1-sized sensors in a non-embeddable PTFE housing with PNP Changeover output.

With operating distances from 0 to 30 mm, Contrinex High performance range capacitive sensors are the ideal solution for difficult sensing tasks in demanding industries and environments.

SERIES AND PARALLEL CONNECTION

Capacitive 2-wire sensors with binary output can be used in series or parallel connection, similar to mechanical contacts. Attention has to be paid to the device-specific voltage drop, i.e. the residual voltage U_{gr} , which multiplies in the case of series connection according to the number of devices. In the case of parallel connection of sensors with thyristor output, the first switching output takes the whole load current.

ADJUSTMENT OF THE OPERATING DISTANCE

Equipped with a 20-turn potentiometer, these Contrinex sensors allow for adjustment of the operating distance, which can be either longer than or shorter than the rated operating distance. Under favorable conditions, an operating distance of up to the maximum given value can be set.

MOUNTING

As with inductive sensors, two kinds of mounting are distinguished for capacitive sensors: embeddable or non-embeddable.

Sensors for embeddable installation in metal or other materials can be arranged side by side, and are particularly suitable for the contact-free detection of solid bodies or liquid levels through non-metallic dividing walls (max. wall thickness 4 mm).

When mounting two or more sensors for non-embeddable installation side by side in metal or other materials, some free space must be provided. Non-embeddable sensors are particularly suitable for applications where the medium to be detected comes into contact with the sensing head (e.g. level monitoring of bulk material, pastes or liquids).



Inductive

Photoelectric

Ultrasonic

Capacitive

Safety

RFID

Connectivity

Accessories

Glossary

Index



COST EFFECTIVE WITH ANY TARGET MATERIAL

BASIC

CAPACITIVE SENSORS

KEY ADVANTAGES

- ✓ Synthetic housings
- ✓ For the detection of all kind of materials
- ✓ Adjustable operating distances
- ✓ Easy potentiometer set-up
- ✓ 4-wire devices

RANGE OVERVIEW	Housing size	Cylindrical	AC / DC	Cubic
BASIC	M12	p. 319		
	M18	p. 320-321		
	M30	p. 321-322	p. 321-322	
	48.5 x 32 x 17 mm			p. 323
	120 x 80 x 30 mm			p. 323

OVERVIEW

Ambient temperature range	-25 ... +70 °C / -13 ... +158 °F
Setup	Potentiometer

HOUSING SIZE
OPERATING DISTANCE MM

WIRING DIAGRAMS

PNP Changeover outputs

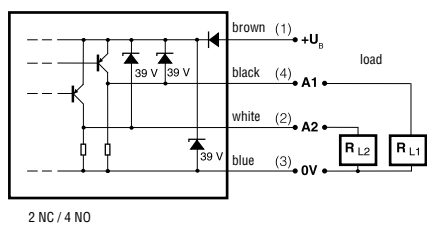

PNP normally open (NO)

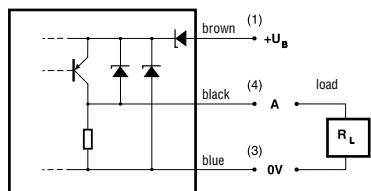

2-wire AC/DC

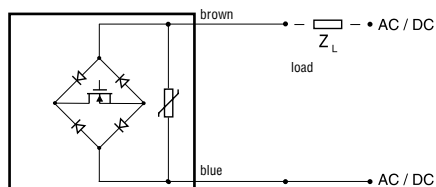

CAPACITIVE

DATA
Op. distance min./max. adjustable
Housing material
Sensing face material
Degree of protection
Mounting
Max. switching frequency
LED
Supply voltage range
PNP Changeover
Other types available

BASIC

M12	M12	M12	M12
2	2	2	2

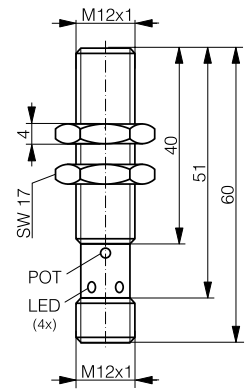
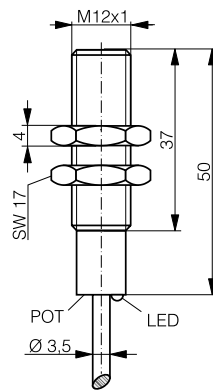
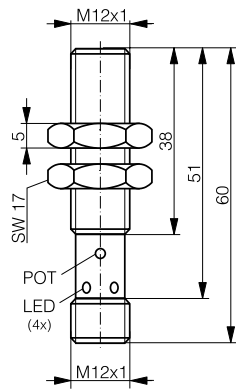
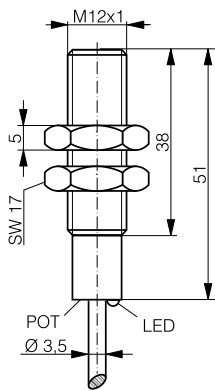

Inductive

Photoelectric

Ultrasonic

Capacitive

Safety

RFID

Connectivity

Accessories

Glossary

Index

0.5 ... 5 mm	0.5 ... 5 mm	0.5 ... 5 mm	0.5 ... 5 mm
PPO	PPO	Stainless steel V2A	Stainless steel V2A
PPO	PPO	PPO	PPO
IP 67	IP 67	IP 67	IP 67
Embeddable	Embeddable	Embeddable	Embeddable
300 Hz	50 Hz	300 Hz	300 Hz
Yellow	Yellow / green	Yellow	Yellow
12 ... 30 VDC	10 ... 35 VDC	12 ... 30 VDC	12 ... 30 VDC
CSK-1121-203	CSS-1120-203	CSK-1121-103	CSS-1121-103

BASIC

CAPACITIVE

HOUSING SIZE	M18	M18	M18
OPERATING DISTANCE MM	5	5	8

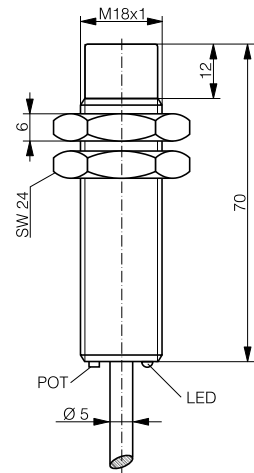
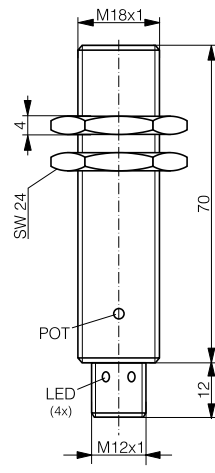
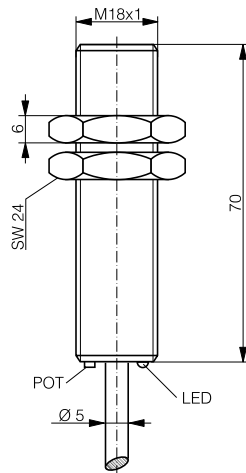

DATA			
Op. distance min./max. adjustable	1 ... 8 mm	1 ... 8 mm	1 ... 10 mm
Housing material	PPO	PPO	PPO
Sensing face material	PPO	PPO	PPO
Degree of protection	IP 67	IP 67	IP 67
Mounting	Embeddable	Embeddable	Non-embeddable
Max. switching frequency	200 Hz	200 Hz	50 Hz
LED	Yellow	Yellow	Yellow
Supply voltage range	12 ... 30 VDC	12 ... 30 VDC	12 ... 30 VDC
PNP Changeover	CSK-1181-203	CSS-1181-203	CSK-1181-213
AC/DC 2-wire NO			
Other types available			

BASIC

M18	M30	M30	M30
8	10	10	10

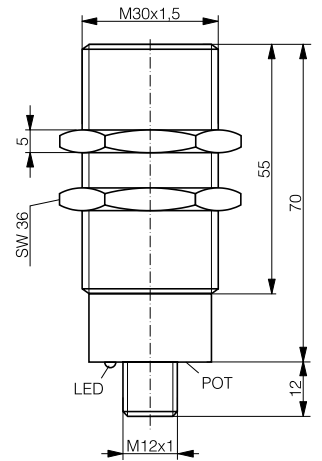
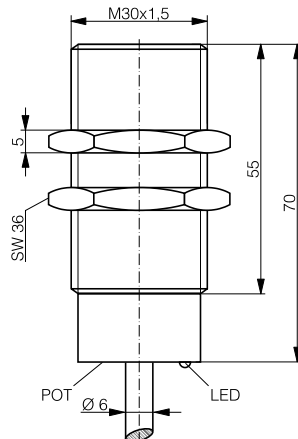
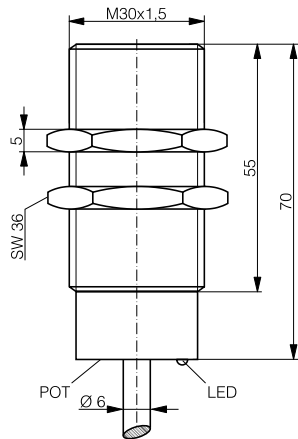
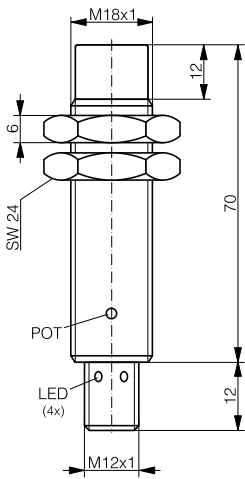

1 ... 10 mm	2 ... 20 mm	2 ... 20 mm	2 ... 20 mm
PPO	PPO	PPO	PPO
PPO	PPO	PPO	PPO
IP 67	IP 67	IP 67	IP 67
Non-embeddable	Embeddable	Embeddable	Embeddable
50 Hz	25 Hz	150 Hz	150 Hz
Yellow	Yellow	Yellow	Yellow
12 ... 30 VDC	20 ... 250 VDC	12 ... 30 VDC	12 ... 30 VDC
CSS-1181-213	CSK-1300-207	CSK-1301-203	CSS-1301-203

Inductive

Photoelectric

Ultrasonic

Capacitive

Safety

RFID

Connectivity

Accessories

Glossary

Index

BASIC

HOUSING SIZE

M30

M30

M30

OPERATING DISTANCE MM

15

15

15

CAPACITIVE

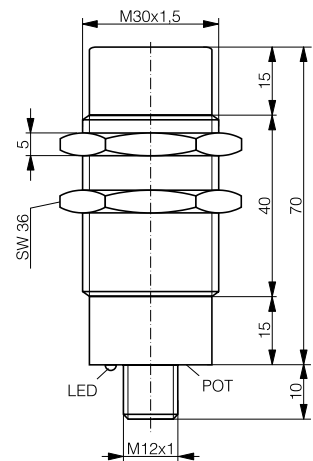
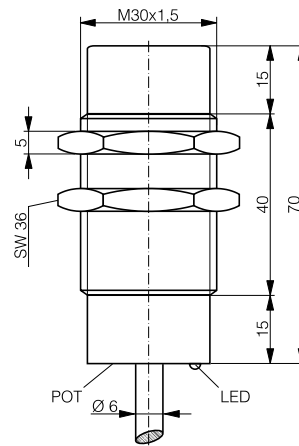
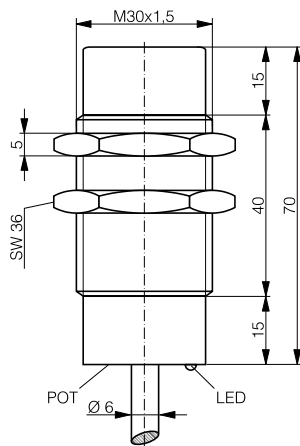

DATA

Op. distance min./max. adjustable	2 ... 25 mm	2 ... 25 mm	2 ... 25 mm
Housing material	PPO	PPO	PPO
Sensing face material	PPO	PPO	PPO
Degree of protection	IP 67	IP 67	IP 67
Mounting	Non-embeddable	Non-embeddable	Non-embeddable
Max. switching frequency	25 Hz	50 Hz	50 Hz
LED	Yellow	Yellow	Yellow
Supply voltage range	20 ... 250 VDC	12 ... 30 VDC	12 ... 30 VDC
PNP Changeover		CSK-1301-213	CSS-1301-213
AC/DC 2-wire NO	CSK-1300-217		
PNP NO			
Other types available			

BASIC

□ 48.5 x 32 x 17

15

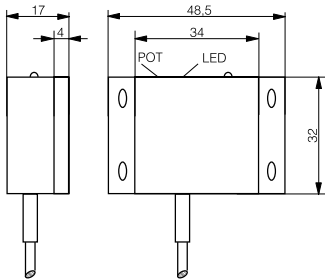

□ 120 x 80 x 30

40

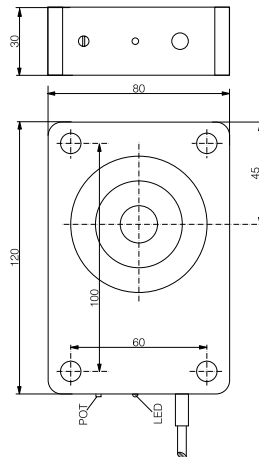

Inductive

Photoelectric

Ultrasonic

Capacitive

Safety

RFID

Connectivity

Accessories

Glossary

Index

0 ... 17 mm

PVC

PVC

IP 67

Embeddable

50 Hz

Yellow / green

10 ... 30 VDC

CSK-3320-208

2 ... 70 mm

PBTP

PBTP

IP 67

Non-embeddable

50 Hz

Yellow / green

10 ... 35 VDC

CSK-3800-213



RELIABLE IN CHALLENGING SITUATIONS

HIGH PERFORMANCE CAPACITIVE SENSORS

KEY ADVANTAGES

- ✓ Metal or PTFE housing
- ✓ Medium optimized performance
- ✓ FDA compliant housings for hygienic applications
- ✓ Reliable detection of viscous and sticky materials
- ✓ Adjustable operating distances
- ✓ 3- and 4-wire devices

RANGE OVERVIEW	Housing size	Cylindrical
HIGH PERFORMANCE	M12	p. 327
	M18	p. 328
	M30	p. 328-329
	∅ 26 / G1	p. 329

OVERVIEW

Ambient temperature range	-25 ... +70 °C / -13 ... +158 °F
Setup	Potentiometer

HOUSING SIZE	
OPERATING DISTANCE MM	

CAPACITIVE

WIRING DIAGRAM

PNP Changeover outputs

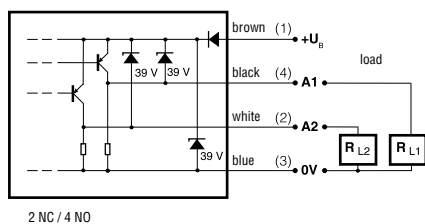

DATA	
Op. distance min./max. adjustable	
Housing material	
Sensing face material	
Degree of protection	
Mounting	
Max. switching frequency	
LED	
Supply voltage range	
PNP Changeover	
Other types available	

HIGH PERFORMANCE

M12	M12	M12	M12
2	2	4	4

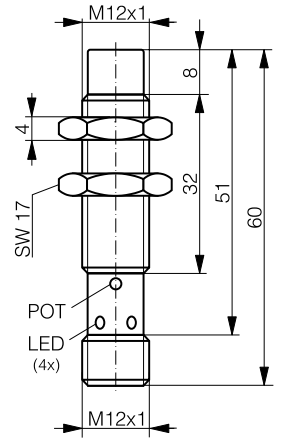
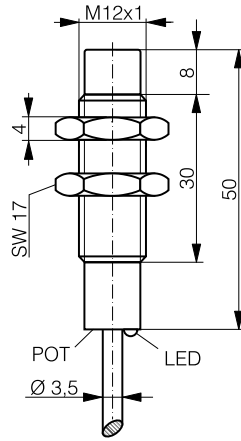
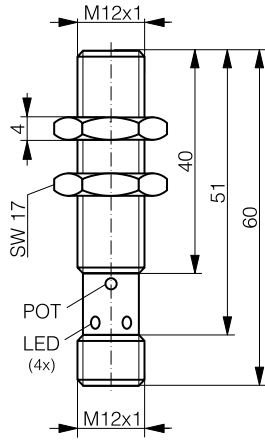
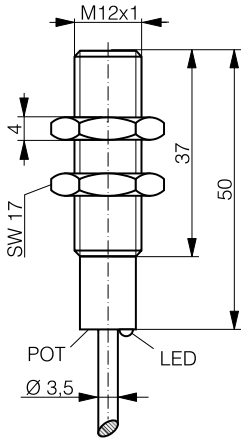

Inductive

Photoelectric

Ultrasonic

Capacitive

Safety

RFID

Connectivity

Accessories

Glossary

Index

0 ... 6 mm	0 ... 6 mm	1 ... 8 mm	1 ... 8 mm
Stainless steel V2A	Stainless steel V2A	Stainless steel V2A	Stainless steel V2A
PTFE	PTFE	PTFE	PTFE
IP 67	IP 67	IP 67	IP 67
Embeddable	Embeddable	Non-embeddable	Non-embeddable
500 Hz	500 Hz	50 Hz	50 Hz
Yellow / green	Yellow / green	Yellow	Yellow
10 ... 35 VDC	10 ... 35 VDC	12 ... 30 VDC	12 ... 30 VDC
CSK-1120-103	CSS-1120-103	CSK-1120-113	CSS-1120-113

HIGH PERFORMANCE

HOUSING SIZE

M18

M18

M30

OPERATING DISTANCE MM

5

8

10

CAPACITIVE

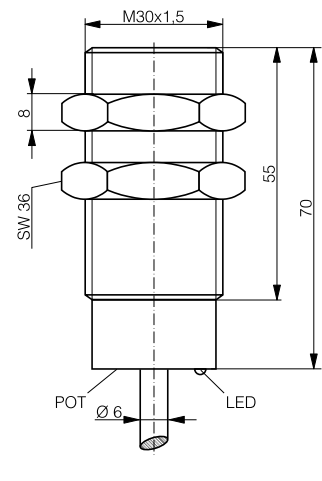
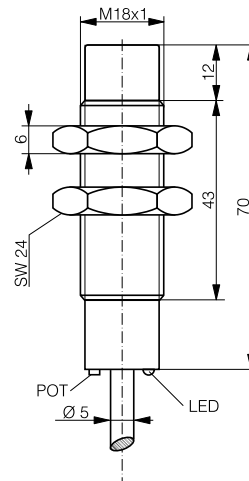
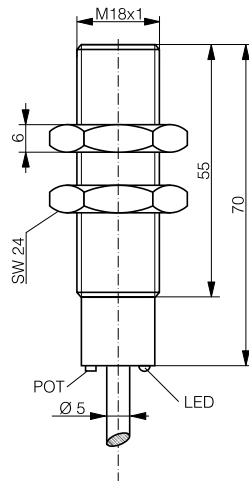

DATA

Op. distance min./max. adjustable	0.5 ... 10 mm	0.5 ... 15 mm	0.5 ... 25 mm
Housing material	PTFE	PTFE	PTFE
Sensing face material	PTFE	PTFE	PTFE
Degree of protection	IP 67	IP 67	IP 67
Mounting	Embeddable	Non-embeddable	Embeddable
Max. switching frequency	300 Hz	50 Hz	200 Hz
LED	Yellow / green	Yellow / green	Yellow / green
Supply voltage range	10 ... 35 VDC	10 ... 35 VDC	10 ... 35 VDC
PNP Changeover	CSK-1180-303	CSK-1180-313	CSK-1300-303
Other types available			

HIGH PERFORMANCE

M30	M30	Ø 26/G1	Ø 26/G1
15	15	5	5



Inductive

Photoelectric

Ultrasonic

Capacitive

Safety

RFID

Connectivity

Accessories

Glossary

Index

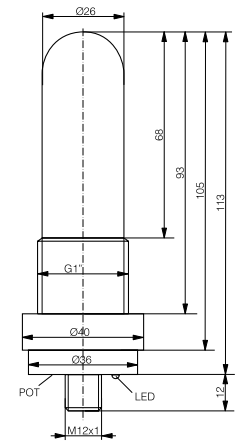
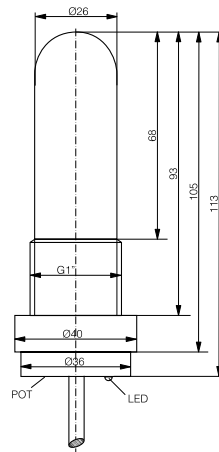
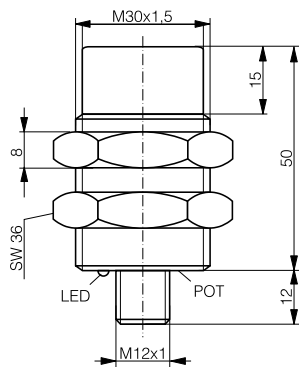
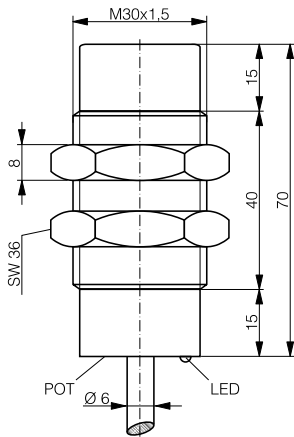

1 ... 30 mm	1 ... 30 mm	0 ... 20 mm	0 ... 20 mm
PTFE	PTFE	PTFE	PTFE
PTFE	PTFE	PTFE	PTFE
IP 67	IP 67	IP 67	IP 67
Non-embeddable	Non-embeddable	Non-embeddable	Non-embeddable
50 Hz	50 Hz	50 Hz	50 Hz
Yellow / green	Yellow / green	Yellow / green	Yellow / green
10 ... 35 VDC	10 ... 35 VDC	10 ... 35 VDC	10 ... 35 VDC
CSK-1300-313	CSS-1300-313	GSK-2260-313	GSS-2260-313

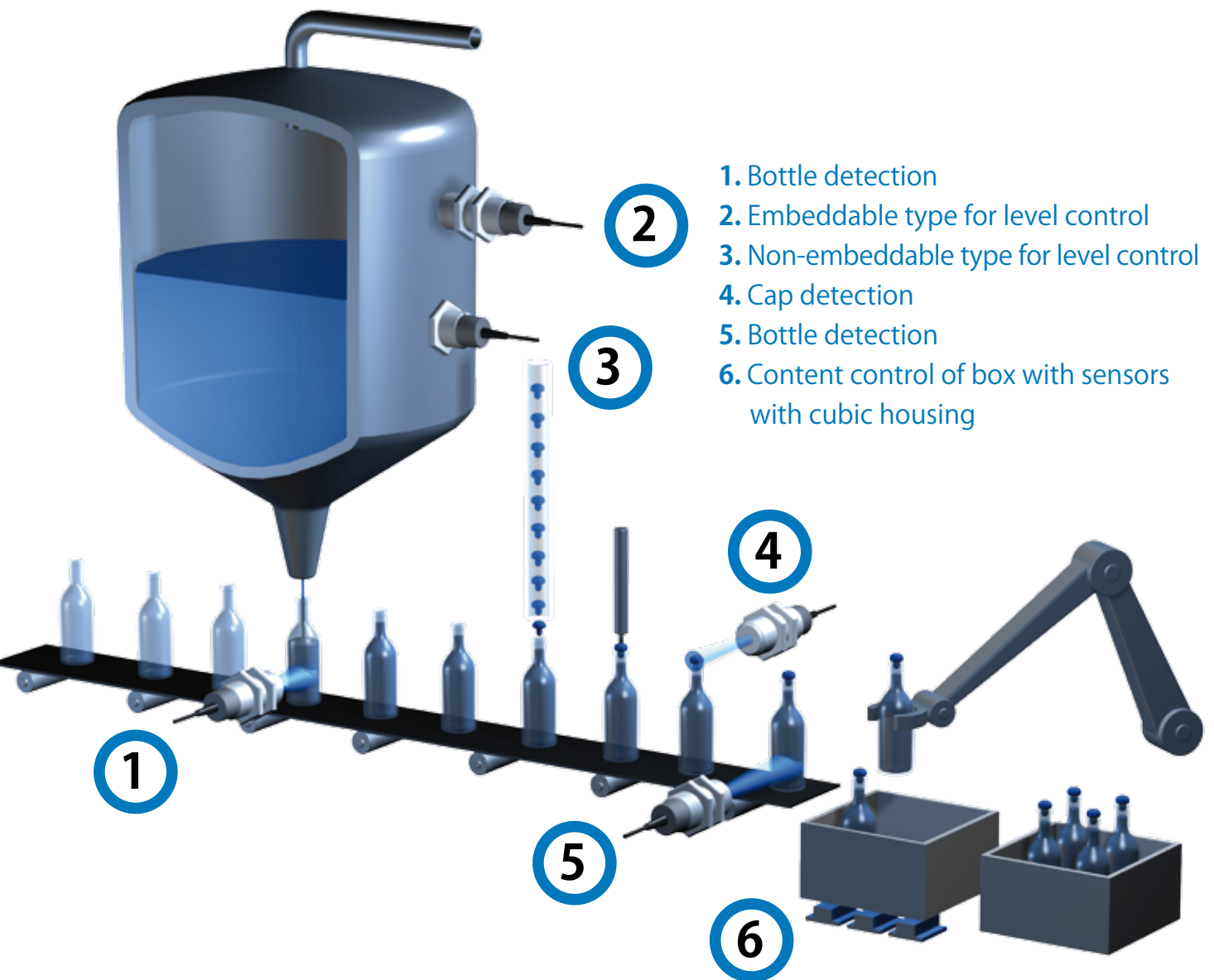

CAPACITIVE SENSORS

CSK-1120-103

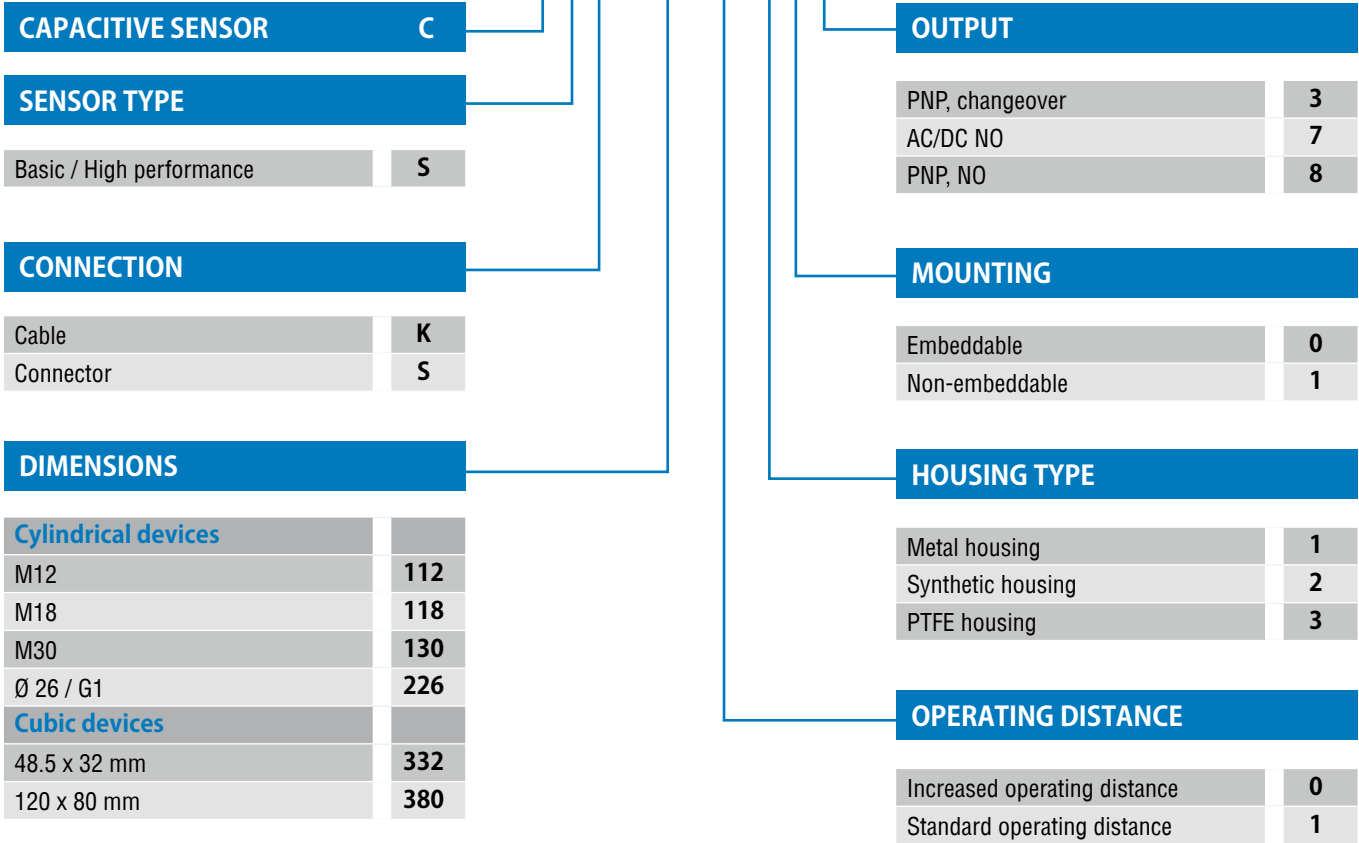

CAPACITIVE SENSORS

<i>Part reference</i>	<i>Chapter/page</i>	<i>Part reference</i>	<i>Chapter/page</i>
CSK-1120-103	4/327	CSS-1120-103	4/327
CSK-1120-113	4/327	CSS-1120-113	4/327
CSK-1121-103	4/319	CSS-1120-203	4/319
CSK-1121-203	4/319	CSS-1121-103	4/319
CSK-1180-303	4/328	CSS-1181-203	4/320
CSK-1180-313	4/328	CSS-1181-213	4/321
CSK-1181-203	4/320	CSS-1300-313	4/329
CSK-1181-213	4/320	CSS-1301-203	4/321
CSK-1300-207	4/321	CSS-1301-213	4/322
CSK-1300-217	4/322	CSS-2260-313	4/329
CSK-1300-303	4/328		
CSK-1300-313	4/329		
CSK-1301-203	4/321		
CSK-1301-213	4/322		
CSK-2260-313	4/329		
CSK-3320-208	4/323		
CSK-3800-213	4/323		

Inductive

Photoelectric

Ultrasonic

Capacitive

Safety

RFID

Connectivity

Accessories

Glossary

Index



ALL OVER THE WORLD

EUROPE

Austria
Belgium*
Croatia
Czech Republic
Denmark
Estonia
Finland
France*
Germany*
Great Britain*
Greece
Hungary
Ireland
Italy*
Luxembourg
Netherlands
Norway
Poland
Portugal*
Romania
Russian Federation
Slovakia
Slovenia

Spain
Sweden
Switzerland*
Turkey
Ukraine

AFRICA

Morocco
South Africa

THE AMERICAS

Argentina
Brazil*
Canada
Chile
Mexico*
Peru
United States*
Venezuela

ASIA

China*
India*

Indonesia
Japan*
Korea
Malaysia
Pakistan
Philippines
Singapore*
Taiwan
Thailand
Vietnam

AUSTRALASIA

Australia
New Zealand

MIDDLE EAST

Israel
United Arab Emirates

* Contrinex subsidiary

Terms of delivery and right to change design reserved.

EUROPE

CONTRINEX AG Industrial Electronics
route André Piller 50 - PO Box - CH 1762 Givisiez - Switzerland
Tel: +41 26 460 46 46 - Fax: +41 26 460 46 40
www.contrinex.com

NORTH AMERICA

CONTRINEX INC
1421 Champion Dr - Ste 308 - Carrollton, Texas 75006 - USA
Tel: +1 972 685 3010 - Fax: +1 972 685 6957
www.contrinexusa.com



customer.service@contrinex.com

Toll Free: 1-866-289-2899